

PUMP HANDBOOK

Copyright 2016 GRUNDFOS Management A/S. All rights reserved.

Copyright law and international treaties protect this material. No part of this material may be reproduced in any form or by any means without prior written permission from GRUNDFOS Management A/S.

Disclaimer

All reasonable care has been taken to ensure the accuracy of the contents of this material, however GRUNDFOS Management A/S shall not be reliable for any loss whether direct, indirect, incidental or consequential arising out of the use of or reliance upon any of the content of the material.

Foreword

The manufacturing industry places heavy demand on pumps, when it comes to optimum operation, high reliability and low energy consumption. Therefore, Grundfos has developed the Pump handbook, which in a simple manner deals with various considerations when dimensioning pumps and pump systems. We have elaborated a handbook for engineers and technicians who work with design and installation of pumps and pump systems, containing answers to a wide range of technical pump specific questions. The Pump handbook can either be read from one end to the other or partly on specific topics.

The handbook is divided into 5 chapters which deal with different phases when designing pump systems.

Throughout chapter 1 we make a general presentation of different pump types and components. Here we also describe which precautions to adopt when dealing with viscous liquids. Further, the most used materials as well as different types of corrosion are presented here. The most important terminologies in connection with reading the pump performance are presented in chapter 2. Chapter 3 deals with system hydraulics and some of the most important factors to consider to obtain optimum operation of the pump system. As it is often necessary to adjust the pump performance by means of different adjustment methods, these are dealt with in chapter 4. Chapter 5 describes the life cycle costs as energy consumption plays an important role in today's pumps and pump systems.

We sincerely hope that you will make use of the Pump handbook and find it useful in your daily work.

Grundfos Industry Segment

Table of Contents

Chapter 1 Design of pumps and motors 7

Section 1.1 Pump construction 8

1.1.1	The centrifugal pump.....	8
1.1.2	Pump curves.....	9
1.1.3	Characteristics of the centrifugal pump.....	11
1.1.4	Most common end-suction and in-line pump types.....	12
1.1.5	Impeller types (axial forces).....	14
1.1.6	Casing types (radial forces).....	15
1.1.7	Single-stage pumps.....	15
1.1.8	Multistage pumps.....	16
1.1.9	Long-coupled and close-coupled pumps.....	16

Section 1.2 Types of pumps 17

1.2.1	Standard pumps.....	17
1.2.2	Split-case pumps.....	17
1.2.3	Hermetically sealed pumps.....	18
1.2.4	Wastewater pumps.....	20
1.2.5	Immersible pumps.....	21
1.2.6	Borehole pumps.....	22
1.2.7	Dosing pumps.....	23

Section 1.3 Mechanical shaft seals 25

1.3.1	The mechanical shaft seal's components and function.....	27
1.3.2	Balanced and unbalanced shaft seals.....	28
1.3.3	Types of mechanical shaft seals.....	29
1.3.4	Seal face material combinations.....	32
1.3.5	Factors affecting the seal performance.....	34

Section 1.4 Motors 37

1.4.1	Standards.....	38
1.4.2	Motor start-up.....	44
1.4.3	Voltage supply.....	45
1.4.4	Frequency converter.....	45
1.4.5	Motor protection.....	47

Section 1.5 Liquids..... 51

1.5.1	Viscous liquids.....	52
1.5.2	Non-Newtonian liquids.....	53
1.5.3	The impact of viscous liquids on the performance of a centrifugal pump.....	53
1.5.4	Selecting the right pump for a liquid with antifreeze.....	54
1.5.5	Calculation example.....	56
1.5.6	Computer-aided pump selection for dense and viscous liquids.....	56

Section 1.6 Materials 57

1.6.1	What is corrosion?.....	58
1.6.2	Types of corrosion.....	59
1.6.3	Metal and metal alloys.....	63
1.6.4	Ceramics.....	69
1.6.5	Plastics.....	69
1.6.6	Rubber.....	70
1.6.7	Coatings.....	71

Chapter 2 Installation and performance reading..... 73

Section 2.1 Pump installation 74

2.1.1	New installation.....	74
2.1.2	Existing installation-replacement.....	74
2.1.3	Pipe flow for single-pump installation.....	75
2.1.4	Limitation of noise and vibrations.....	76
2.1.5	Sound level (L).....	79

Section 2.2 Pump performance 81

2.2.1	Hydraulic terms.....	81
2.2.2	Electrical terms.....	88
2.2.3	Liquid properties.....	91

Chapter 3 System hydraulic 93

Section 3.1 System characteristics 94

- 3.1.1 Single resistances 95
- 3.1.2 Closed and open systems 96

Section 3.2 Pumps connected in series and parallel 99

- 3.2.1 Pumps in parallel 99
- 3.2.2 Pumps connected in series 101

Chapter 4 Performance adjustment of pumps 103

Section 4.1 Adjusting pump performance 104

- 4.1.1 Throttle control 105
- 4.1.2 Bypass control 105
- 4.1.3 Modifying impeller diameter 106
- 4.1.4 Speed control 106
- 4.1.5 Comparison of adjustment methods 108
- 4.1.6 Overall efficiency of the pump system 109
- 4.1.7 Example: Relative power consumption when the flow is reduced by 20% 109

Section 4.2 Speed-controlled pump solutions 112

- 4.2.1 Constant pressure control 112
- 4.2.2 Constant temperature control 113
- 4.2.3 Constant differential pressure in a circulating system 113
- 4.2.4 Flow-compensated differential pressure control 114

Section 4.3 Advantages of speed control 115

Section 4.4 Advantages of pumps with integrated frequency converter 116

- 4.4.1 Performance curves of speed-controlled pumps 117
- 4.4.2 Speed-controlled pumps in different systems 117

Section 4.5 Frequency converter 120

- 4.5.1 Basic function and characteristics 120
- 4.5.2 Components of the frequency converter 120
- 4.5.3 Special conditions regarding frequency converters 122

Chapter 5 Life cycle costs calculation 125

Section 5.1 Life cycle costs equation 126

- 5.1.1 Initial costs, purchase price (C_{ic}) 127
- 5.1.2 Installation and commissioning costs (C_{in}) 127
- 5.1.3 Energy costs (C_e) 128
- 5.1.4 Operating costs (C_o) 128
- 5.1.5 Environmental costs (C_{env}) 128
- 5.1.6 Maintenance and repair costs (C_m) 129
- 5.1.7 Downtime costs, loss of production (C_s) 129
- 5.1.8 Decommissioning and disposal costs (C_d) 129

Section 5.2 Life cycle costs calculation – an example 130

Appendix 131

- A) Notations and units 132
- B) Unit conversion tables 133
- C) SI-prefixes and Greek alphabet 134
- D) Vapour pressure and density of water at different temperatures 135
- E) Orifice 136
- F) Change in static pressure due to change in pipe diameter 137
- G) Nozzles 138
- H) Nomogram for head losses in bends, valves, etc 139
- I) Pipe loss nomogram for clean water 20°C 140
- J) Periodical system 141
- K) Pump standards 142
- L) Viscosity for different liquids as a function of liquid temperature 143

Index 148

Chapter 1. Design of pumps and motors

Section 1.1: Pump construction

- 1.1.1 The centrifugal pump
- 1.1.2 Pump curves
- 1.1.3 Characteristics of the centrifugal pump
- 1.1.4 Most common end-suction and in-line pump types
- 1.1.5 Impeller types (axial forces)
- 1.1.6 Casing types (radial forces)
- 1.1.7 Single-stage pumps
- 1.1.8 Multistage pumps
- 1.1.9 Long-coupled and close-coupled pumps

Section 1.2: Types of pumps

- 1.2.1 Standard pumps
- 1.2.2 Split-case pumps
- 1.2.3 Hermetically sealed pumps
- 1.2.4 Sanitary pumps
- 1.2.5 Wastewater pumps
- 1.2.6 Immersible pumps
- 1.2.7 Borehole pumps
- 1.2.8 Positive displacement pumps



Section 1.1

Pump construction

1.1.1 The centrifugal pump

In 1689 the physicist Denis Papin invented the centrifugal pump and today this kind of pump is the most used around the world. The centrifugal pump is built on a simple principle: Liquid is led to the impeller hub and by means of the centrifugal force it is flung towards the periphery of the impellers.

The construction is fairly inexpensive, robust and simple and its high speed makes it possible to connect the pump directly to an asynchronous motor. The centrifugal pump provides a steady liquid flow, and it can easily be throttled without causing any damage to the pump.

Now let us have a look at figure 1.1.1, which shows the liquid's flow through the pump. The inlet of the pump leads the liquid to the centre of the rotating impeller from where it is flung towards the periphery. This construction gives a high efficiency and is suitable for handling pure liquids. Pumps, which have to handle impure liquids, such as wastewater pumps, are fitted with an impeller that is constructed especially to avoid that objects get stocked inside the pump, see section 1.2.5.

If a pressure difference occurs in the system while the centrifugal pump is not running, liquid can still pass through it due to its open design.

As you can tell from figure 1.1.2, the centrifugal pump can be categorised in different groups: Radial flow pumps, mixed flow pumps and axial flow pumps. Radial flow pumps and mixed flow pumps are the most common types used. Therefore, we will only concentrate on these types of pumps on the following pages.

However, we will briefly present the positive displacement pump in section 1.2.8.

The different demands on the centrifugal pump's performance, especially with regard to head, flow, and installation, together with the demands for economical operation, are only a few of the reasons why so many types of pump exist. Figure 1.1.3 shows the different pump types with regard to flow and pressure.

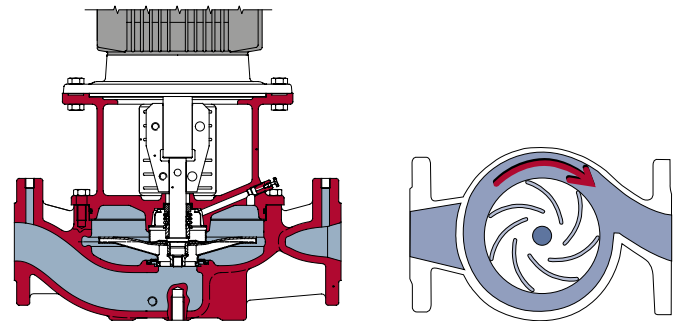


Fig. 1.1.1: The liquid's flow through the pump

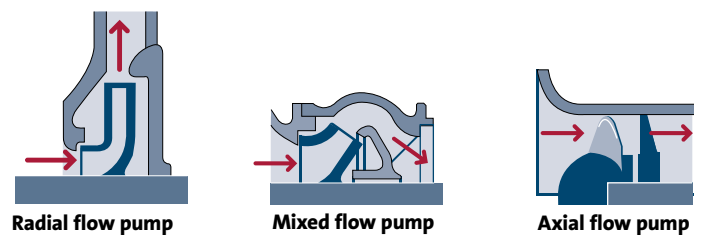


Fig. 1.1.2: Different kinds of centrifugal pumps

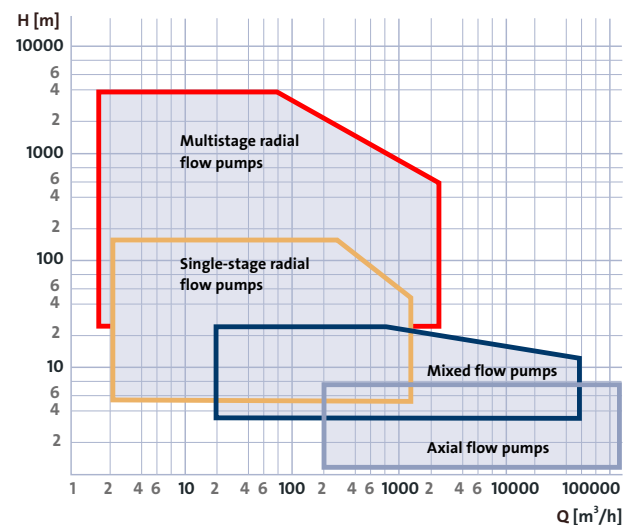


Fig. 1.1.3: Flow and head for different types of centrifugal pumps



1.1.2 Pump curves

Before we dig any further into the world of pump construction and pump types, we will present the basic characteristics of pump performance curves. The performance of a centrifugal pump is shown by a set of performance curves. The performance curves for a centrifugal pump are shown in figure 1.1.4. Head, power consumption, efficiency and NPSH are shown as a function of the flow.

Normally, pump curves in data booklets only cover the pump part. Therefore, the power consumption, the P_2 -value, which is listed in the data booklets as well, only covers the power going into the pump – see figure 1.1.4. The same goes for the efficiency value, which only covers the pump part ($\eta = \eta_p$).

In some pump types with integrated motor and possibly integrated frequency converter, e.g. canned motor pumps (see section 1.2.3), the power consumption curve and the η -curve cover both the motor and the pump. In this case it is the P_1 -value that has to be taken into account.

In general, pump curves are designed according to ISO 9906 Annex A, which specifies the tolerances of the curves:

- $Q \pm 9\%$,
- $H \pm 7\%$,
- $P + 9\%$
- $\eta - 7\%$.

What follows is a brief presentation of the different pump performance curves.

Head, the QH-curve

The QH-curve shows the head, which the pump is able to perform at a given flow. Head is measured in meter liquid column [mLC]; normally the unit meter [m] is applied. The advantage of using the unit [m] as the unit of measurement for a pump's head is that the QH-curve is not affected by the type of liquid the pump has to handle, see section 2.2 for more information.

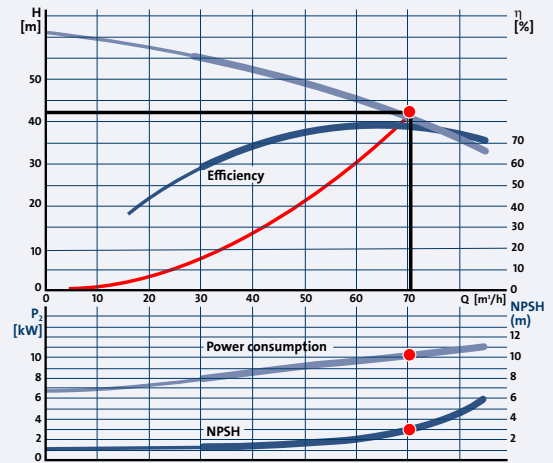


Fig. 1.1.4: Typical performance curves for a centrifugal pump. Head, power consumption, efficiency and NPSH are shown as a function of the flow

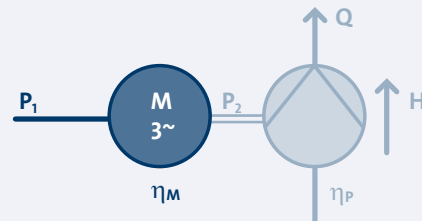


Fig. 1.1.5: The curves for power consumption and efficiency will normally only cover the pump part of the unit – i.e. P_2 and η_p

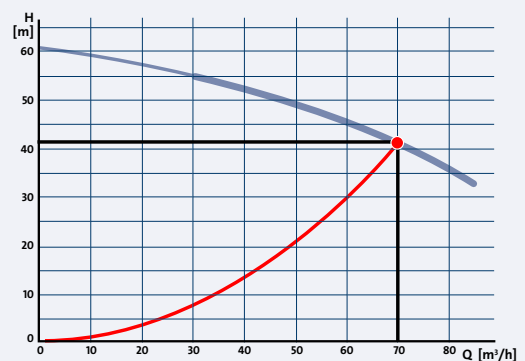


Fig. 1.1.6: A typical QH-curve for a centrifugal pump; low flow results in high head and high flow results in low head

Section 1.1

Pump construction

Efficiency, the η -curve

The efficiency is the relation between the supplied power and the utilised amount of power. In the world of pumps, the efficiency η_P is the relation between the power, which the pump delivers to the water (P_H) and the power input to the shaft (P_2):

$$\eta_p = \frac{P_H}{P_2} = \frac{\rho \cdot g \cdot Q \cdot H}{P_2 \times 3600}$$

where:

ρ is the density of the liquid in kg/m^3 ,
 g is the acceleration of gravity in m/s^2 ,
 Q is the flow in m^3/h and H is the head in m .

For water at 20°C and with Q measured in m^3/h and H in m , the hydraulic power can be calculated as :

$$P_H = 2.72 \cdot Q \cdot H \text{ [W]}$$

As it appears from the efficiency curve, the efficiency depends on the duty point of the pump. Therefore, it is important to select a pump, which fits the flow requirements and ensures that the pump is working in the most efficient flow area.

Power consumption, the P_2 -curve

The relation between the power consumption of the pump and the flow is shown in figure 1.1.8. The P_2 -curve of most centrifugal pumps is similar to the one in figure 1.1.8 where the P_2 value increases when the flow increases.

$$P_2 = \frac{Q \cdot H \cdot g \cdot \rho}{3600 \times \eta_p}$$

NPSH-curve (Net Positive Suction Head)

The NPSH-value of a pump is the minimum absolute pressure (see section 2.2.1) that has to be present at the suction side of the pump to avoid cavitation.

The NPSH-value is measured in $[\text{m}]$ and depends on the flow; when the flow increases, the NPSH-value increases as well; figure 1.1.9. For more information concerning cavitation and NPSH, go to section 2.2.1.

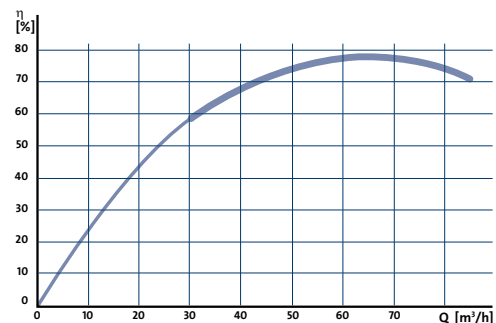


Fig. 1.1.7: The efficiency curve of a typical centrifugal pump

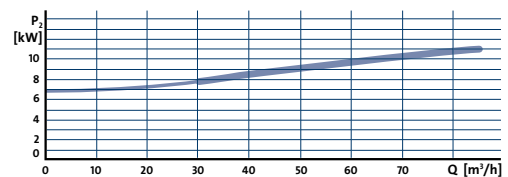


Fig. 1.1.8: The power consumption curve of a typical centrifugal pump

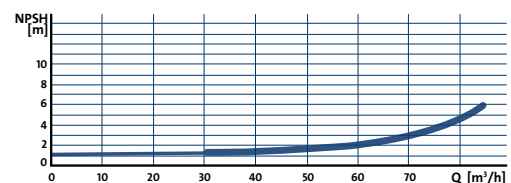


Fig. 1.1.9: The NPSH-curve of a typical centrifugal pump



1.1.3 Characteristics of the centrifugal pump

The centrifugal pump has several characteristics and in this section, we will present the most important ones. Later on in this chapter we will give a more thorough description of the different pump types.

- **The number of stages**

Depending on the number of impellers in the pump, a centrifugal pump can be either a single-stage pump or a multistage pump.

- **The position of the pump shaft**

Single-stage and multistage pumps come with horizontal or vertical pump shafts. These pumps are normally designated horizontal or vertical pumps. For more information, go to section 1.1.4.

- **Single-suction or double-suction impellers**

Depending on the construction of the impeller, a pump can be fitted with either a single-suction impeller or a double-suction impeller. For more information, go to section 1.1.5.

- **Coupling of stages**

The pump stages can be arranged in two different ways: in series and in parallel, see figure 1.1.10.

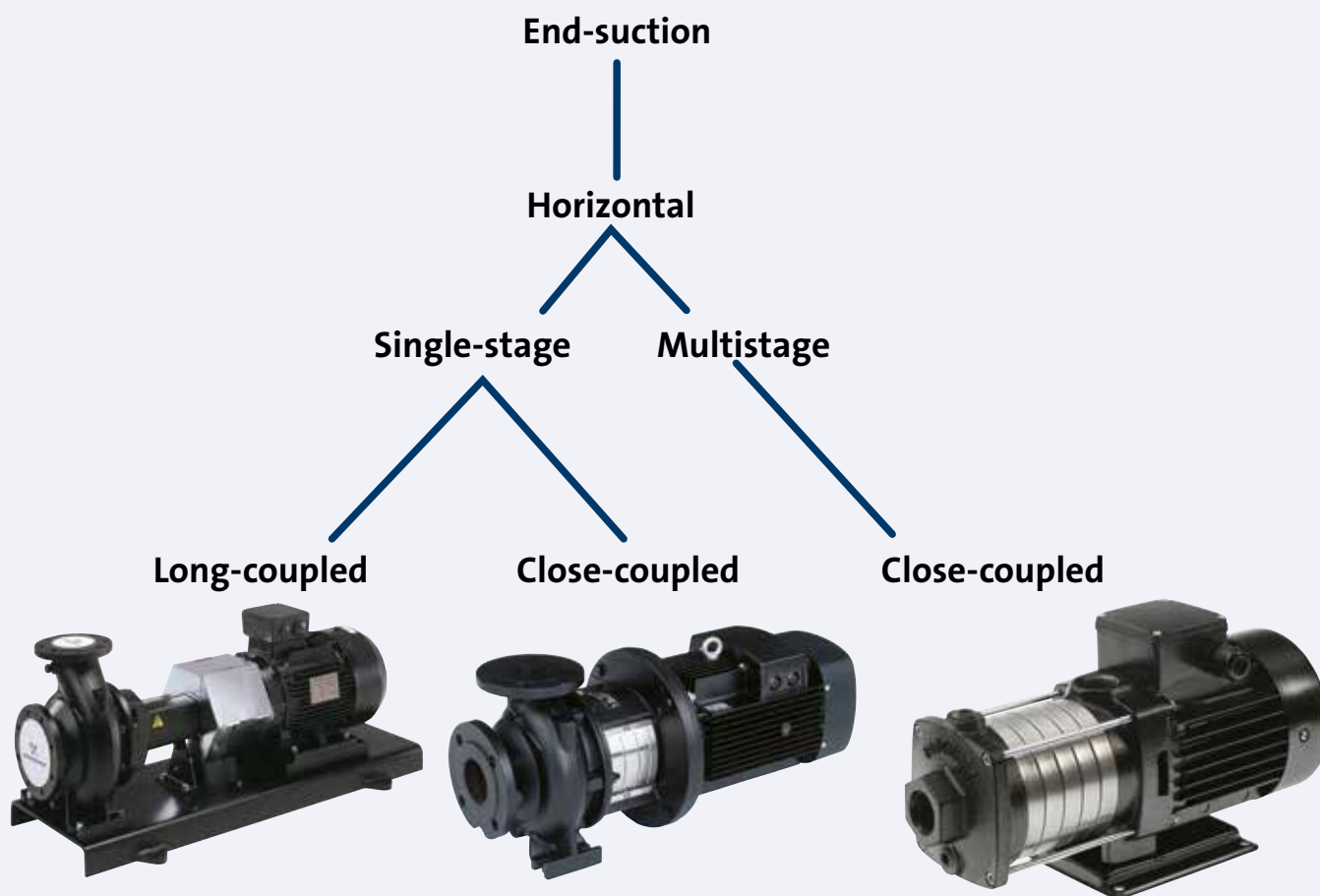
- **Construction of the pump casing**

We distinguish between two types of pump casing: Volute casing and return channel casing with guide vanes. For more information, go to section 1.1.6.

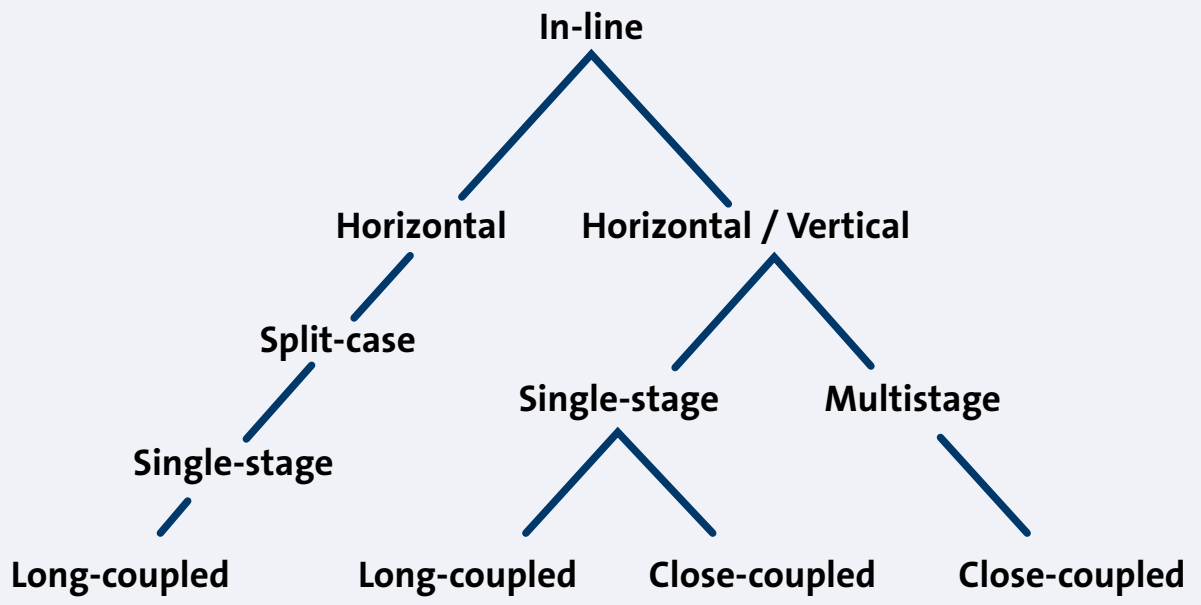


Fig 1.1.10: Twin pump with parallel-coupled impellers

1.1.4 Most common end-suction and in-line pump types



- End-suction pump** = The liquid runs directly into the impeller. Inlet and outlet have a 90° angle. See section 1.1.9
- In-line pump** = The liquid runs directly through the pump in-line. The suction pipe and the discharge pipe are placed opposite one another and can be mounted directly in the piping system
- Split-case pump** = Pump with an axially divided pump housing. See section 1.2.2
- Horizontal pump** = Pump with a horizontal pump shaft
- Vertical pump** = Pump with a vertical pump shaft
- Single-stage pump** = Pump with a single impeller. See section 1.1.7
- Multistage pump** = Pump with several series-coupled stages. See section 1.1.8
- Long-coupled pump** = Pump connected to the motor by means of a flexible coupling. The motor and the pump have separate bearing constructions. See section 1.1.9
- Close-coupled pump** = A pump connected to the motor by means of a rigid coupling. See section 1.1.9



1.1.5 Impeller types (axial forces)

A centrifugal pump generates pressure that exerts forces on both stationary and rotating parts of the pump. Pump parts are made to withstand these forces. If axial and radial forces are not counterbalanced in the pump, the forces have to be taken into consideration when selecting the driving system for the pump (angular contact bearings in the motor). In pumps fitted with single-suction impeller, large axial forces may occur, figures 1.1.11 and 1.1.12. These forces are balanced in one of the following ways:

- Mechanically by means of thrust bearings. These types of bearings are specially designed to absorb the axial forces from the impellers
- By means of balancing holes on the impeller, see figure 1.1.13
- By means of throttle regulation from a seal ring mounted on the back of the impellers, see figure 1.1.14
- Dynamic impact from the back of the impeller, see figure 1.1.15
- The axial impact on the pump can be avoided by using double-suction impellers (see figure 1.1.16).

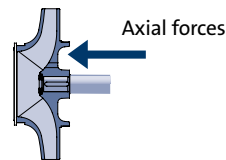


Fig. 1.1.11: Single-suction impeller

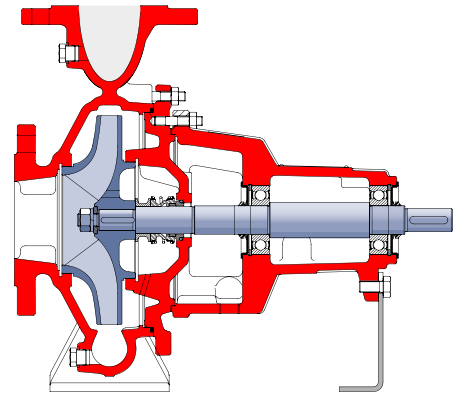


Fig. 1.1.12: Standard pump with single-suction impeller

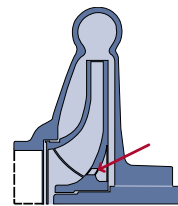


Fig. 1.1.13: Balancing the axial forces in a single-stage centrifugal pump with balancing holes only

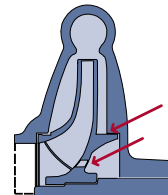


Fig. 1.1.14: Balancing the axial forces in a single-stage centrifugal pump with sealing gap at discharge side and balancing holes

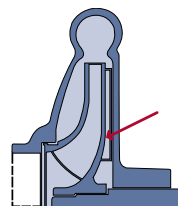


Fig. 1.1.15: Balancing the axial forces in a single-stage centrifugal pump with blades on the back of the impellers

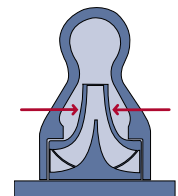


Fig. 1.1.16: Balancing the axial forces in a double-suction impeller arrangement



1.1.6 Casing types (radial forces)

Radial forces are a result of the static pressure in the casing. Therefore, axial deflections may occur and lead to interference between the impeller and the casing. The magnitude and the direction of the radial force depend on the flow rate and the head.

When designing the casing for the pump, it is possible to control the hydraulic radial forces. Two casing types are worth mentioning: the single-volute casing and the double-volute casing. As you can tell from figure 1.1.18, both casings are shaped as a volute. The difference between them is that the double-volute has an guide vane.

The single-volute pump is characterised by a symmetric pressure in the volute at the optimum efficiency point, which leads to zero radial load. At all other points, the pressure around the impeller is not regular and consequently a radial force is present.

As you can tell from figure 1.1.19, the double-volute casing develops a constant low radial reaction force at any capacity.

Return channels (figure 1.1.20) are used in multistage pumps and have the same basic function as volute casings. The liquid is led from one impeller to the next and at the same time, the rotation of water is reduced and the dynamic pressure is transformed into static pressure. Because of the return channel casing's circular design, no radial forces are present.

1.1.7 Single-stage pumps

Generally, single-stage pumps are used in applications, which do not require a total head of more than 150 m. Normally, single-stage pumps operate in the interval of 2-100 m.

Single-stage pumps are characterised by providing a low head relative to the flow, see figure 1.1.3. The single-stage pump comes in both a vertical and a horizontal design, see figures 1.1.21 and 1.1.22.

Fig. 1.1.17: Single-suction impeller

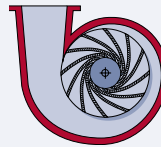
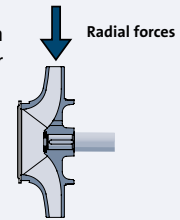


Fig. 1.1.18: Single-volute casing

Double-volute casing

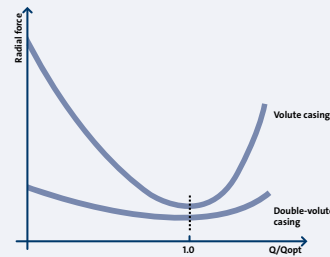


Fig. 1.1.19: Radial force for single and double-volute casing

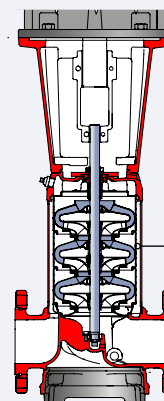


Fig. 1.1.20: Vertical multistage in-line pump with return channel casing

Return channel

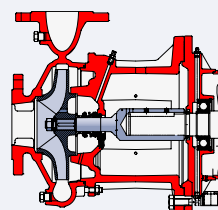


Fig. 1.1.21: Horizontal single-stage end-suction close-coupled pump

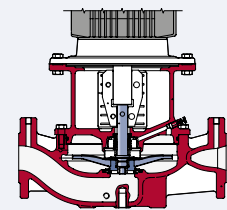


Fig. 1.1.22: Vertical single-stage in-line close-coupled pump

Section 1.1

Pump construction

1.1.8 Multistage pumps

Multistage pumps are used in installations where a high head is needed. Several stages are connected in series and the flow is guided from the outlet of one stage to the inlet of the next. The final head that a multistage pump can deliver is equal to the sum of pressure each of the stages can provide.

The advantage of multistage pumps is that they provide high head relative to the flow. Like the single-stage pump, the multistage pump is available in both a vertical and a horizontal version, see figures 1.1.23 and 1.1.24.

1.1.9 Long-coupled and close-coupled pumps

Long-coupled pumps

Long-coupled pumps are pumps with a flexible coupling that connects the pump and the motor. This kind of coupling is available either as a basic coupling or as a spacer coupling.

If the pump is connected to the motor by a basic coupling, it is necessary to dismount the motor when the pump needs service. Therefore, it is necessary to align the pump upon mounting, see figure 1.1.25.

On the other hand, if the pump is fitted with a spacer coupling, it is possible to service the pump without dismounting the motor. Alignment is thus not an issue, see figure 1.1.26.

Close-coupled pumps

Close-coupled pumps can be constructed in the following two ways: Either the pump has the impeller mounted directly on the extended motor shaft or the pump has a standard motor and a rigid or a spacer coupling, see figures 1.1.27 and 1.1.28.

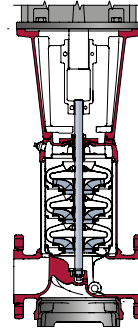


Fig. 1.1.23: Vertical multistage in-line pump

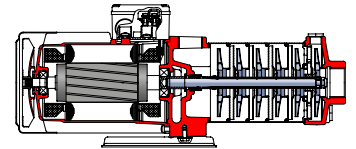


Fig. 1.1.24: Horizontal multistage end-suction pump

Fig. 1.1.25: Long-coupled pump with basic coupling

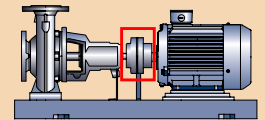


Fig. 1.1.26: Long-coupled pump with spacer coupling

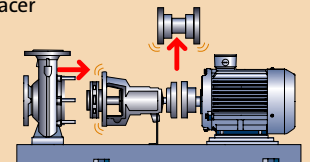
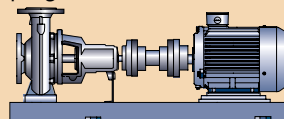


Fig. 1.1.27: Close-coupled pump with rigid coupling

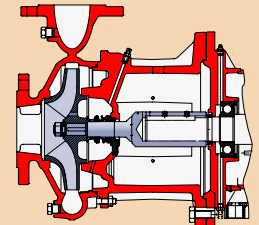
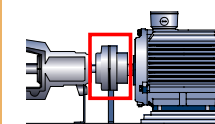
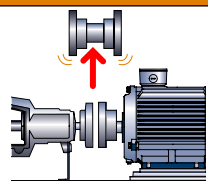
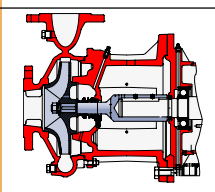
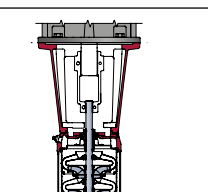


Fig. 1.1.28: Different coupling types

	Basic coupling type	Spacer coupling (option)
Long-coupled pump with flexible coupling		
Close-coupled pump with rigid coupling		

Section 1.2

Types of pumps



1.2.1 Standard pumps

Few international standards deal with centrifugal pumps. In fact, many countries have their own standards, which more or less overlap one another. A standard pump is a pump that complies with official regulations as to for example the pump's duty point. What follows, are a couple of examples of international standards for pumps:

- EN 733 (DIN 24255) applies to end-suction centrifugal pumps, also known as standard water pumps with a rated pressure (PN) of 10 bar.
- EN 22858 (ISO 2858) applies to centrifugal pumps, also known as standard chemical pumps with a rated pressure (PN) of 16 bar, see appendix K.

The standards mentioned above cover the installation dimensions and the duty points of the different pump types. As to the hydraulic parts of these pump types, they vary according to the manufacturer – thus, no international standards are set for these parts.

Pumps, which are designed according to standards, provide the end-user with advantages with regard to installation as well as service, spare parts and maintenance.

1.2.2 Split-case pumps

A split-case pump is a pump with the pump housing divided axially into two parts. Figure 1.2.4 shows a single-stage split-case pump with a double-suction impeller. The double-inlet construction eliminates the axial forces and ensures a longer life span of the bearings. Usually, split-case pumps have a rather high efficiency, are easy to service and have a wide performance range.



Fig. 1.2.1: Long-coupled standard pump

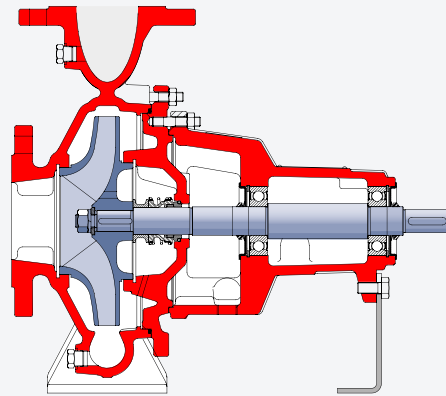


Fig. 1.2.2: Bare shaft standard pump



Fig. 1.2.3: Long-coupled split-case pump

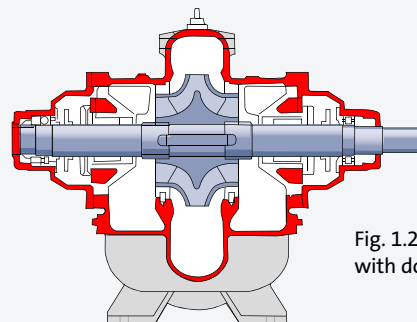


Fig. 1.2.4: Split-case pump with double-suction impeller

Section 1.2

Types of pumps

1.2.3 Hermetically sealed pumps

It comes as no surprise that a pump's shaft lead-in has to be sealed. Usually, this is done by means of a mechanical shaft seal, see figure 1.2.5. The disadvantage of the mechanical shaft seal is its poor properties when it comes to handling of toxic and aggressive liquids, which consequently lead to leakage. These problems can to some extent be solved by using a double mechanical shaft seal. Another solution to these problems is to use a hermetically sealed pump.

We distinguish between two types of hermetically sealed pumps: Canned motor pumps and magnetic-driven pumps. In the following two sections, you can find additional information about these pumps.

Canned motor pumps

A canned motor pump is a hermetically sealed pump with the motor and pump integrated in one unit without a seal, see figures 1.2.6 and 1.2.7. The pumped liquid is allowed to enter the rotor chamber that is separated from the stator by a thin rotor can. The rotor can serves as a hermetically sealed barrier between the liquid and the motor. Chemical pumps are made of materials, e.g. plastics or stainless steel that can withstand aggressive liquids.

The most common canned motor pump type is the circulator pump. This type of pump is typically used in heating circuits because the construction provides low noise and maintenance-free operation.

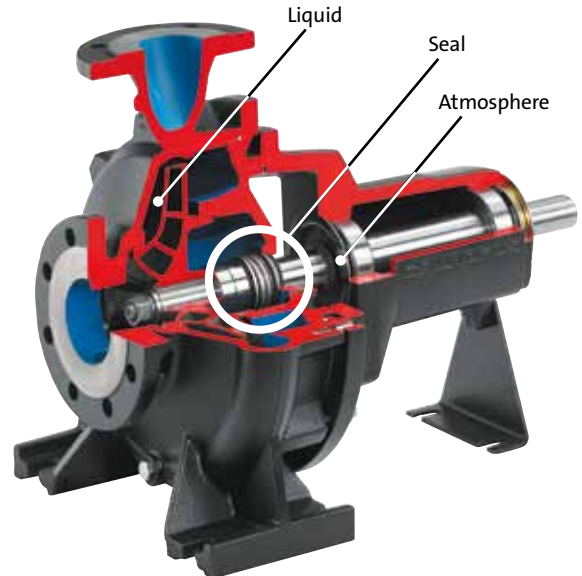


Fig. 1.2.5: Example of a standard pump with mechanical shaft seal

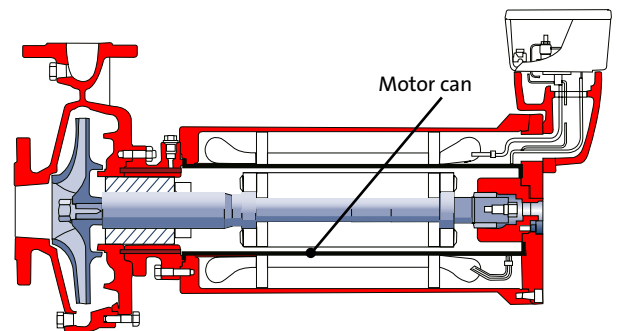


Fig. 1.2.6: Chemical pump with canned motor

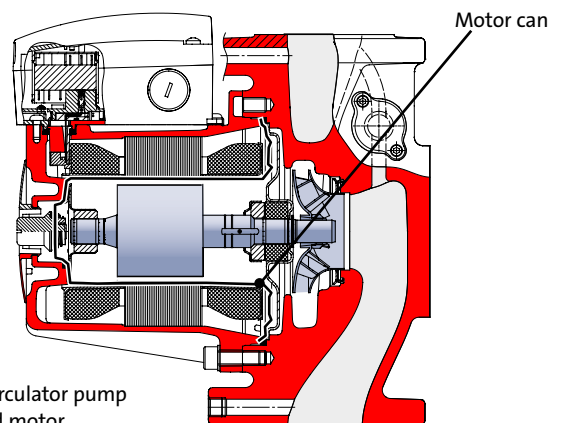


Fig. 1.2.7: Circulator pump with canned motor



Magnetic-driven pumps

In recent years, magnetic-driven pumps have become increasingly popular for transferring aggressive and toxic liquids.

As shown in figure 1.2.8, the magnetic-driven pump is made of two groups of magnets; an inner magnet and an outer magnet. A non-magnetizable can separate these two groups. The can serves as a hermetically sealed barrier between the liquid and the atmosphere. As it appears from figure 1.2.9, the outer magnet is connected to the pump drive and the inner magnet is connected to the pump shaft. Hereby, the torque from the pump drive is transmitted to the pump shaft. The pumped liquid serves as lubricant for the bearings in the pump. Therefore, sufficient venting is crucial for the bearings.

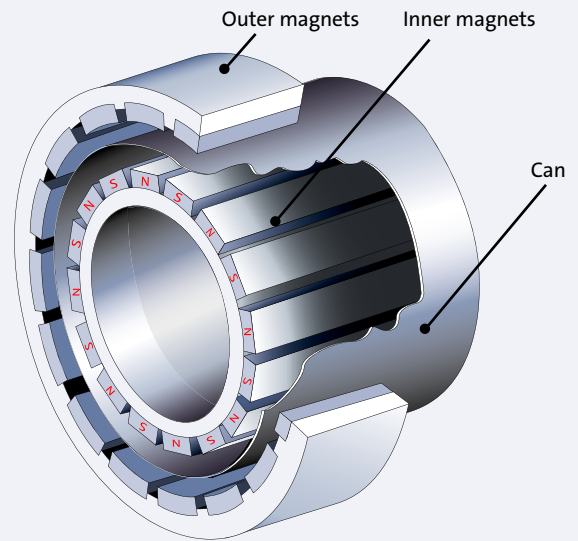


Fig. 1.2.8: Construction of magnetic drive

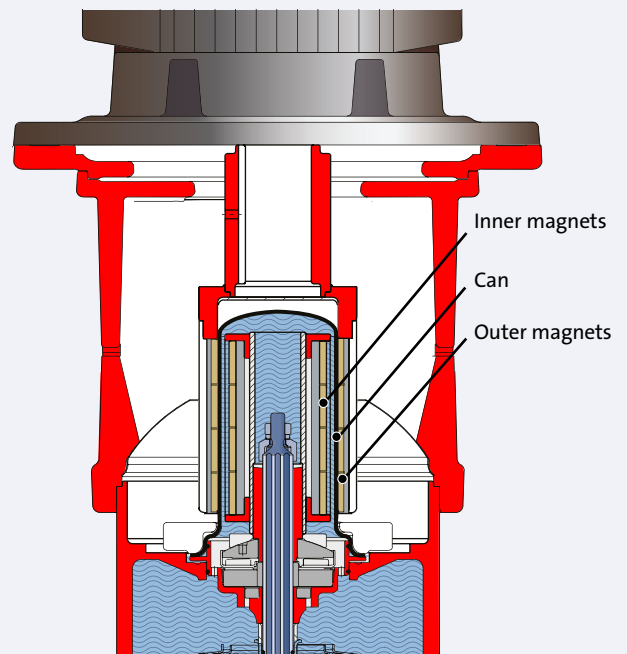


Fig. 1.2.9: Magnetic-driven multistage pump

1.2.4 Wastewater pumps

A wastewater pump is an enclosed unit with a pump and a motor. Due to this construction the wastewater pump is suitable for submersible installation in pits. In submersible installations with auto-coupling systems double rails are normally used. The auto-coupling system facilitates maintenance, repair and replacement of the pump. Because of the construction of the pump, it is not necessary to enter the pit to carry out service. In fact, it is possible to connect and disconnect the pump automatically from the outside of the pit. Wastewater pumps can also be installed dry like conventional pumps in vertical or horizontal installations. Likewise this type of installation provides easy maintenance and repair like it provides uninterrupted operation of the pump in case of flooding of the dry pit, see figure 1.2.14.

Normally, wastewater pumps have to be able to handle large particles. Therefore, they are fitted with special impellers to avoid blockage and clogging. Different types of impellers exist: single-channel impellers, double-channel impellers, three and four-channel impellers and vortex impellers. Figure 1.2.15 shows the different designs of these impellers.

Wastewater pumps usually come with a dry motor, which is IP68 protected (for more information on IP-classes, go to section 1.4.1). Motor and pump have a common extended shaft with a double mechanical shaft seal system in an intermediate oil chamber, see figure 1.2.13. Wastewater pumps are able to operate either intermittently or continuously depending on the installation in question.

Fig.1.2.13: Detail of a sewage pump for wet installations



Fig. 1.2.14: Wastewater pump for dry installations

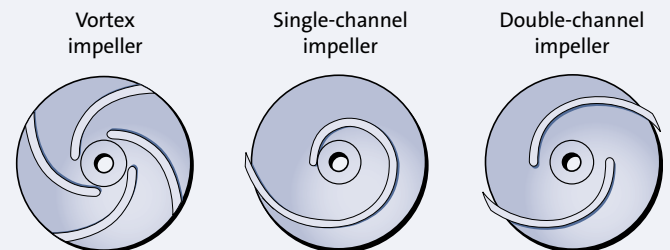


Fig. 1.2.15: Impeller types for wastewater



1.2.5 Immersible pumps

An immersible pump is a pump type where the pump part is immersed in the pumped liquid and the motor is kept dry. Normally, immersible pumps are mounted on top of or in the wall of tanks or containers. Immersible pumps are for example used in the machine tool industry, for example in spark machine tools, grinding machines, machining centres and cooling units or in other industrial applications involving tanks or containers, such as industrial washing and filtering systems.

Pumps for machine tools can be divided into two groups: Pumps for the clean side of the filter and pumps for the dirty side of the filter. Pumps with closed impellers are normally used for the clean side of the filter, because they provide a high efficiency and a high pressure if necessary. Pumps with open or semi-open impellers are normally used for the dirty side of the filter, because they can handle metal chips and particles.

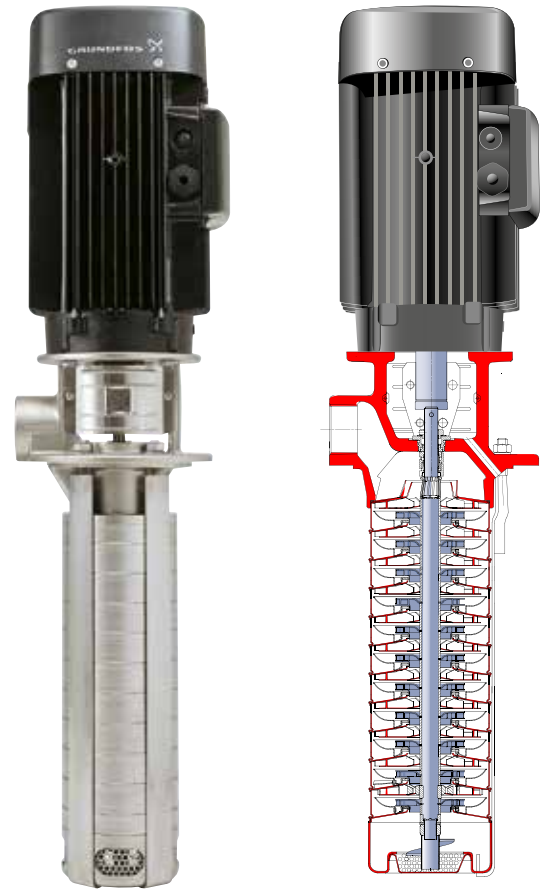


Fig. 1.2.16: Immersible pump

1.2.6 Borehole pumps

Two types of borehole pumps exist: The submerged borehole pump type with a submersible motor, and the deep well pump with a dry motor, which is connected to the pump by a long shaft. These pumps are normally used in connection with water supply and irrigation. Both pump types are made to be installed in deep and narrow boreholes and have thus a reduced diameter, which makes them longer than other pump types, see figure 1.2.17.

The borehole pumps are specially designed to be submerged in a liquid and are thus fitted with a submersible motor, which is IP68 protected. The pump comes in both a single-stage and a multistage version (the multistage version being the most common one), and is fitted with a non-return valve in the pump head.

Today, the deep well pump has been more or less replaced by the submerged pump type. The long shaft of the deep well pump is a drawback, which makes it difficult to install and carry out service. Because the deep well pump motor is air-cooled, the pump is often used in industrial applications to pump hot water from open tanks. The submersible pump cannot handle as high temperatures because the motor is submerged in the liquid, which has to cool it.

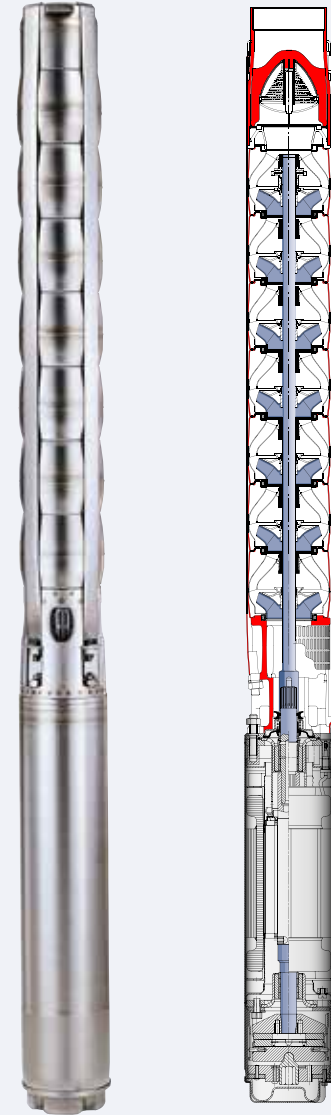


Fig. 1.2.17: Submersible pump



1.2.7 Dosing pumps

The dosing pump belongs to the positive displacement pump family and is typically of the diaphragm type. Diaphragm pumps are leakage-free, because the diaphragm forms a seal between the liquid and the surroundings.

The diaphragm pump is fitted with two non-return valves – one on the suction side and one on the discharge side of the pump. In connection with smaller diaphragm pumps, the diaphragm is activated by the connecting rod, which is connected to an electromagnet. Thereby, the coil receives the exact amount of strokes needed, see figure 1.2.21.

In connection with larger diaphragm pumps the diaphragm is typically mounted on the connecting rod, which is activated by a camshaft. The camshaft is turned by means of a standard asynchronous motor, see figure 1.2.22.

The flow of a diaphragm pump is adjusted by either changing the stroke length and/or the frequency of the strokes. If it is necessary to enlarge the operating area, frequency converters can be connected to the larger diaphragm pumps, see figure 1.2.22.

Yet, another kind of diaphragm pump exists. In this case, the diaphragm is activated by means of an eccentrically driven connecting rod powered by a stepper motor or a synchronous motor, figures 1.2.20 and 1.2.23. By using a stepper motor drive the pump's dynamic area is increased and its accuracy is improved considerably. With this construction it is no longer necessary to adjust the pump's stroke length because the connection rod is mounted directly on the diaphragm. The result is optimised suction conditions and excellent operation features.

So therefore, it is simple to control both the suction side and the discharge side of the pump. Compared to traditional electromagnetic-driven diaphragm pumps which provide powerful pulsations, stepper motor-driven diaphragm pumps make it possible to get a much more steady dosage of additive.



Fig. 1.2.20: Dosing pump

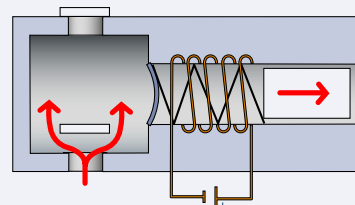
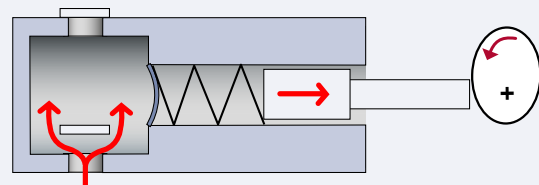
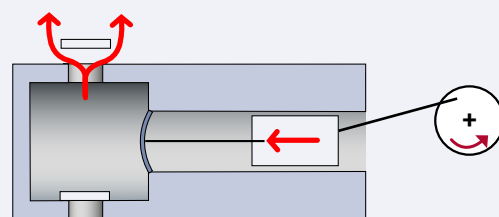


Fig.1.2.21: Solenoid spring return



1.2.22: Cam-drive spring return



1.2.23: Crank drive

Section 1.3: Mechanical shaft seals

- 1.3.1 The mechanical shaft seal's components and function
- 1.3.2 Balanced and unbalanced shaft seals
- 1.3.3 Types of mechanical shaft seals
- 1.3.4 Seal face material combinations
- 1.3.5 Factors affecting the seal performance



Section 1.3

Mechanical shaft seals

From the middle of the 1950s mechanical shaft seals gained ground in favour of the traditional sealing method - the stuffing box. Compared to stuffing boxes, mechanical shaft seals provide the following advantages:

- They keep tight at smaller displacements and vibrations in the shaft
- They do not require any adjustment
- Seal faces provide a small amount of friction and thus, minimise the power loss
- The shaft does not slide against any of the seal's components and thus, is not damaged because of wear (reduced repair costs).

The mechanical shaft seal is the part of a pump that separates the liquid from the atmosphere. In figure 1.3.1 you can see a couple of examples where the mechanical shaft seal is mounted in different types of pumps.

The majority of mechanical shaft seals are made according to the European standard EN 12756.

Before choosing a shaft seal, there are certain things you need to know about the liquid and thus the seal's resistance to the liquid:

- Determine the type of liquid
- Determine the pressure that the shaft seal is exposed to
- Determine the speed that the shaft seal is exposed to
- Determine the built-in dimensions

On the following pages we will present how a mechanical shaft seal works, the different types of seal, which kind of materials mechanical shaft seals are made of and which factors that affect the mechanical shaft seal's performance.



Fig. 1.3.1: Pumps with mechanical shaft seals

1.3.1 The mechanical shaft seal's components and function

The mechanical shaft seal is made of two main components: a rotating part and a stationary part; and consists of the parts listed in figure 1.3.2. Figure 1.3.3 shows where the different parts are placed in the seal.

- The stationary part of the seal is fixed in the pump housing. The rotating part of the seal is fixed on the pump shaft and rotates when the pump operates.
- The two primary seal faces are pushed against each other by the spring and the liquid pressure. During operation a liquid film is produced in the narrow gap between the two seal faces. This film evaporates before it enters the atmosphere, making the mechanical shaft seal liquid tight, see figure 1.3.4.
- Secondary seals prevent leakage from occurring between the assembly and the shaft.
- The spring presses the seal faces together mechanically.
- The spring retainer transmits torque from the shaft to the seal. In connection with mechanical bellows shaft seals, torque is transferred directly through the bellows.

Seal gap

During operation the liquid forms a lubricating film between the seal faces. This lubricating film consists of a hydrostatic and a hydrodynamic film.

- The hydrostatic element is generated by the pumped liquid which is forced into the gap between the seal faces.
- The hydrodynamic lubricating film is created by pressure generated by the shaft's rotation.



Mechanical shaft seal	Designation
Rotating part	Seal face (primary seal)
	Secondary seal
	Spring
	Spring retainer (torque transmission)
Stationary part	Seat (seal faces, primary seal)
	Static seal (secondary seal)

Fig. 1.3.2: The mechanical shaft seal's components

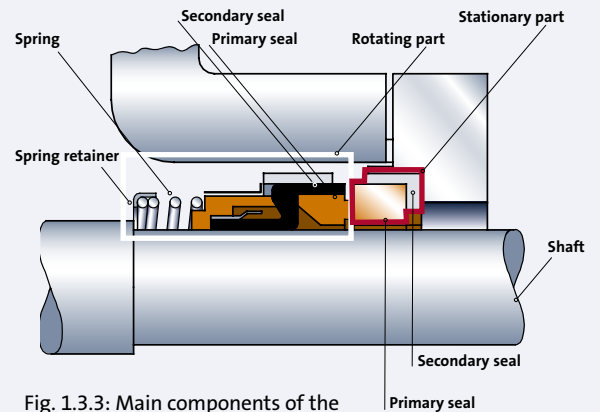


Fig. 1.3.3: Main components of the mechanical shaft seal

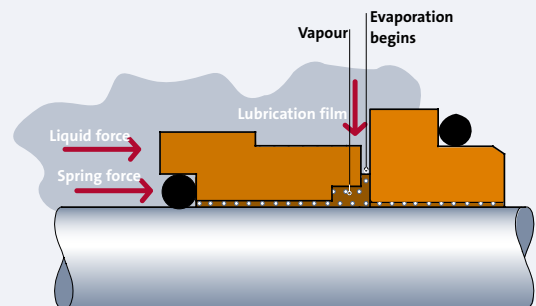


Fig. 1.3.4: Mechanical shaft seal in operation

Section 1.3

Mechanical shaft seals

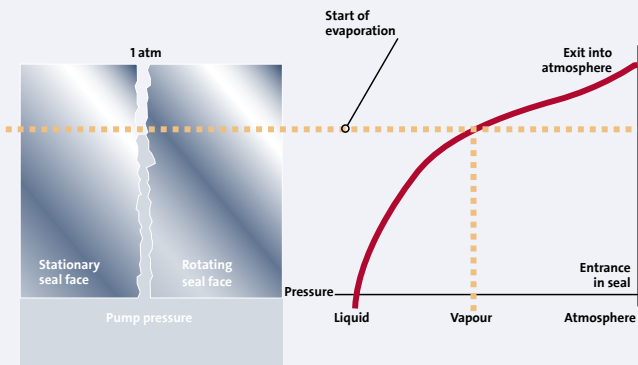


Fig. 1.3.5: Optimum ratio between fine lubrication properties and limited leakage

The thickness of the lubricating film depends on the pump speed, the liquid temperature, the viscosity of the liquid and the axial forces of the mechanical shaft seal. The liquid is continuously changed in the seal gap because of

- evaporation of the liquid to the atmosphere
- the liquid's circular movement

Figure 1.3.5 shows the optimum ratio between fine lubrication properties and limited leakage. As you can tell, the optimum ratio is when the lubricating film covers the entire seal gap, except for a very narrow evaporation zone close to the atmospheric side of the mechanical shaft seal.

Leakage due to deposits on the seal faces is often observed. When using coolant agents, deposits are built up quickly by the evaporation at the atmosphere side of the seal. When the liquid evaporates in the evaporation zone, microscopic solids in the liquid remain in the seal gap as deposits creating wear.

These deposits are seen in connection with most types of liquid. But when the pumped liquid has a tendency to crystallise, it can become a problem. The best way to prevent wear is to select seal faces made of hard material, such as tungsten carbide (WC) or silicon carbide (SiC). The narrow seal gap between these materials (app. $0.3 \mu\text{m Ra}$) minimises the risk of solids entering the seal gap and thereby minimises the amount of deposits building up.

1.3.2 Balanced and unbalanced shaft seals

To obtain an acceptable face pressure between the primary seal faces, two kind of seal types exist: a balanced shaft seal and an unbalanced shaft seal.

Balanced shaft seal

Figure 1.3.6 shows a balanced shaft seal indicating where the forces interact on the seal.

Unbalanced shaft seal

Figure 1.3.7 shows an unbalanced shaft seal indicating where the forces interact on the seal.

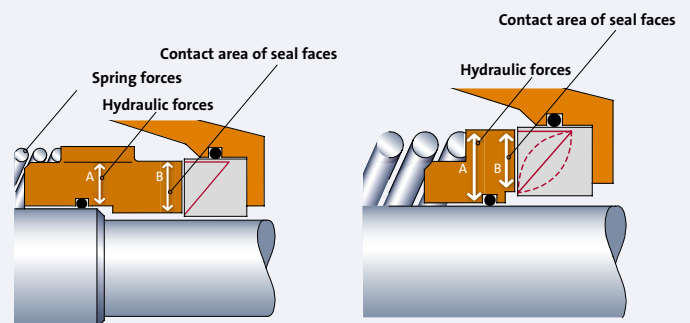


Fig. 1.3.6: Interaction of forces on the balanced shaft seal

Fig. 1.3.7: Interaction of forces on the unbalanced shaft seal

Several different forces have an axial impact on the seal faces. The spring force and the hydraulic force from the pumped liquid press the seal together while the force from the lubricating film in the seal gap counteracts this. In connection with high liquid pressure, the hydraulic forces can be so powerful that the lubricant in the seal gap cannot counteract the contact between the seal faces. Because the hydraulic force is proportionate to the area that the liquid pressure affects, the axial impact can only be reduced by obtaining a reduction of the pressure-loaded area.

The balancing ratio (K) of a mechanical shaft seal is defined as the ratio between the area A and the area (B) :

$$K=A/B$$

K = Balancing ratio
 A = Area exposed to hydraulic pressure
 B = Contact area of seal faces

For balanced shaft seals the balancing ratio is usually around K=0.8 and for unbalanced shaft seals the balancing ratio is normally around K=1.2.

Comparative wear rates valid for water

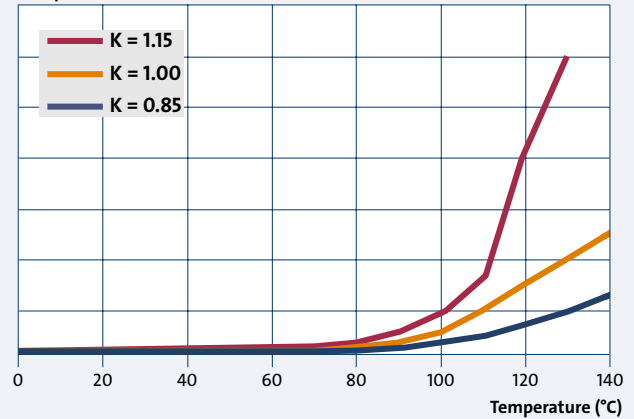


Fig. 1.3.8: Wear rate for different balancing ratios

1.3.3 Types of mechanical shaft seals

What follows is a brief outline of the main types of mechanical shaft seals: O-ring seal, bellows seal, and the one-unit seal - the cartridge seal.

O-ring seals

In an O-ring seal, sealing between the rotating shaft and the rotating seal face is effected by an O-ring (figure 1.3.9). The O-ring must be able to slide freely in the axial direction to absorb axial displacements as a result of changes in temperatures and wear. Incorrect positioning of the stationary seat may result in rubbing and thus unnecessary wear on the O-ring and on the shaft. O-rings are made of different types of rubber material, such as NBR, EPDM and FKM, depending on the operating conditions.

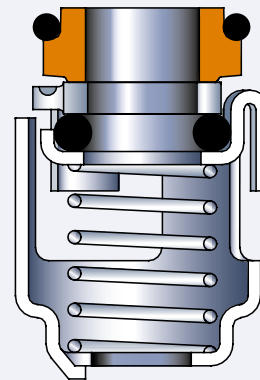


Fig. 1.3.9: O-ring seal

Advantages and disadvantages of O-ring seal

Advantages:

Suitable in hot liquid and high pressure applications

Disadvantages:

Deposits on the shaft, such as rust, may prevent the O-ring shaft seal from moving axially

Bellows seals

A common feature of bellows seals is a rubber or metal bellows which functions as dynamic sealing element between the rotating ring and the shaft.

Rubber bellows seals

The bellows of a rubber bellows seal (see figure 1.3.10) can be made of different types of rubber material, such as NBR, EPDM and FKM, depending on the operating conditions. Two different geometric principles are used for the design of rubber bellows:

- Folding bellows
- Rolling bellows.

Rubber bellows seal with folding bellows geometry

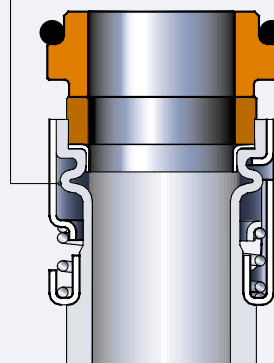


Fig. 1.3.10: Rubber bellows seal

Advantages and disadvantages of rubber bellows seal

Advantages:

Not sensitive to deposits, such as rust, on the shaft

Suitable for pumping solid-containing liquids

Disadvantages:

Not suitable in hot liquid and high pressure applications

Section 1.3

Mechanical shaft seals

Metal bellows seals

In an ordinary mechanical shaft seal, the spring produces the closing force required to close the seal faces. In a metal bellows seal (figure 1.3.11) the spring has been replaced by a metal bellows with a similar force. Metal bellows act both as a dynamic seal between the rotating ring and the shaft and as a spring. The bellows have a number of corrugations to give them the desired spring force.

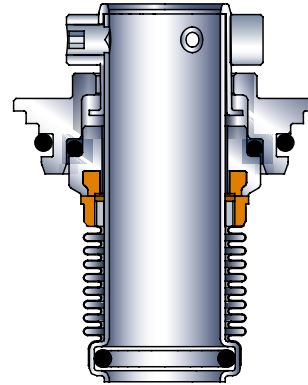


Fig. 1.3.11: Cartridge metal bellows seal

Advantages and disadvantages of cartridge metal bellows seal

Advantages:

Not sensitive to deposits, such as rust and lime on the shaft

Suitable in hot liquid and high-pressure applications

Low balancing ratio leads to low wear rate and consequently longer life

Disadvantages:

Fatigue failure of the mechanical shaft seal may occur when the pump is not aligned correctly

Fatigue may occur as a result of excessive temperatures or pressures

Cartridge seals

In a cartridge mechanical shaft seal, all parts form a compact unit on a shaft sleeve, ready to be installed. A cartridge seal offers many benefits compared to conventional mechanical shaft seals, figure 1.3.12.

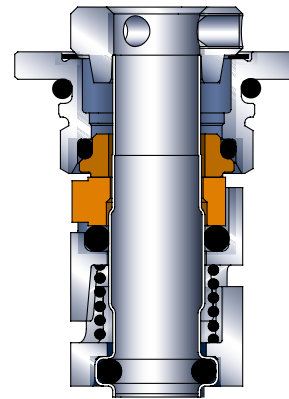


Fig. 1.3.12: Cartridge seal

Advantages of the cartridge seal:

- Easy and fast service
- The design protects the seal faces
- Preloaded spring
- Safe handling

Flushing

In certain applications it is possible to extend the performance of the mechanical shaft seal by installing flushing, see figure 1.3.13. Flushing can lower the temperature of the mechanical shaft seal and prevent deposits from occurring. Flushing can be installed either internally or externally. Internal flushing is done when a small flow from the pump's discharge side is bypassed to the seal area. Internal flushing is primarily used to prevent further heat generation from the seal in heating applications. External flushing is done by a flushing liquid and is used to ensure trouble-free operation when handling liquids that are abrasive or contain clogging solids.

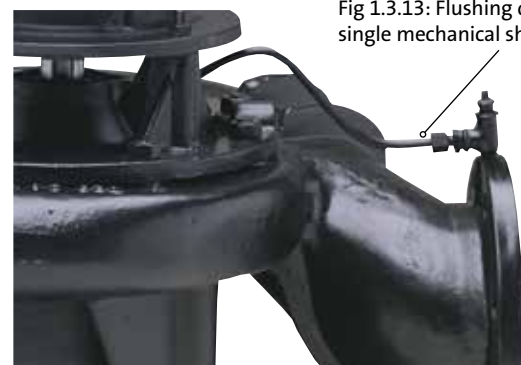


Fig 1.3.13: Flushing device of a single mechanical shaft seal

Double mechanical shaft seals

Double mechanical shaft seals are used when the life span of single mechanical shaft seals is insufficient due to wear caused by solids or too high/low pressure and temperature. Further, double mechanical shaft seals are used in connection with toxic, aggressive and explosive liquids to protect the surroundings. Two types of double mechanical shaft seals exist: The double seal in a tandem arrangement and the double seal in a back-to-back arrangement.

Double seal in tandem

This type of double seal consists of two mechanical shaft seals mounted in tandem, that is one behind the other, placed in a separate seal chamber, see figure 1.3.14.

The tandem seal arrangement has to be fitted with a quenching liquid system which

- absorbs leakage
- monitors the leakage rate
- lubricates and cools the outboard seal to prevent icing
- protects against dry-running
- stabilises the lubricating film
- prevents air from entering the pump in case of vacuum

The pressure of the quenching liquid must always be lower than the pumped liquid pressure.

Tandem - circulation

Circulation of quenching liquid via a pressureless tank, see figure 1.3.14. Quenching liquid from the elevated tank is circulated by thermosiphon action and/or by pumping action in the seal.

Tandem - dead end

Quenching liquid from an elevated tank, see figure 1.3.15. No heat is dissipated from the system.

Tandem - drain

The quenching liquid runs directly through the seal chamber to be collected for reuse, or directed to drain, see figure 1.3.16.

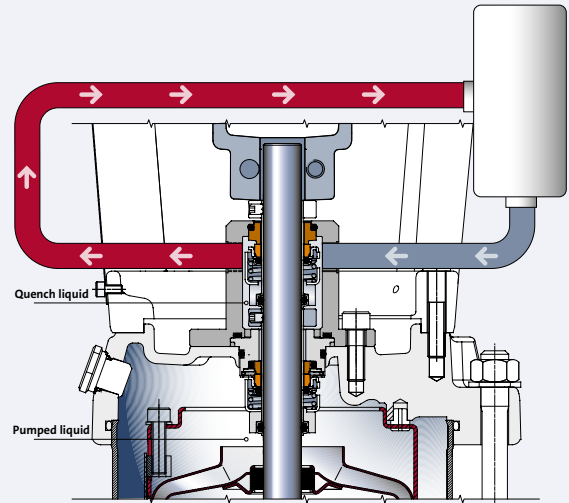


Fig. 1.3.14: Tandem seal arrangement with quench liquid circulation

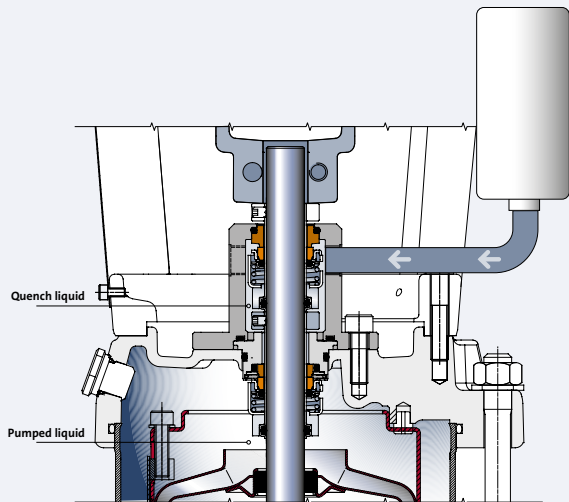


Fig. 1.3.15: Tandem seal arrangement with quench liquid dead end

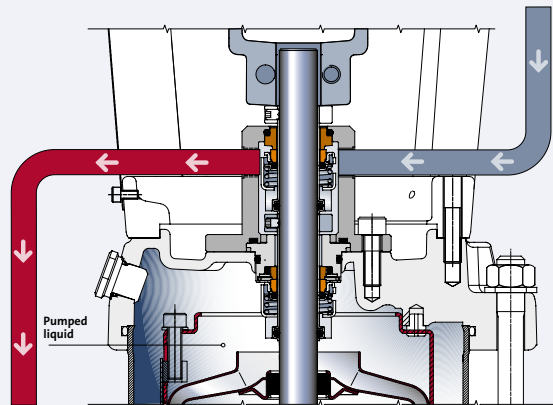


Fig. 1.3.16: Tandem seal arrangement with quench liquid to drain

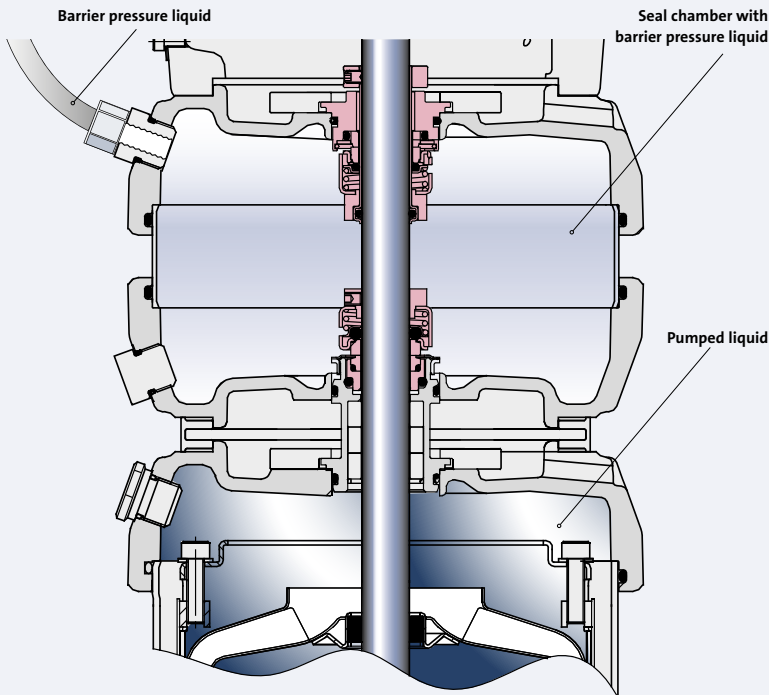


Fig. 1.3.17:
Back-to-back seal arrangement

Double seal in back-to-back

This type of seal is the optimum solution for handling abrasive, aggressive, explosive or sticky liquids, which would either wear out, damage or block a mechanical shaft seal.

The back-to-back double seal consists of two shaft seals mounted back-to-back in a separate seal chamber, see figure 1.3.17. The back-to-back double seal protects the surrounding environment and the people working with the pump.

The pressure in the seal chamber must be 1-2 bar higher than the pump pressure. The pressure can be generated by:

- An existing, separate pressure source. Many applications incorporate pressurised systems.
- A separate pump, e.g. a dosing pump.

1.3.4 Seal face material combinations

What follows is a description of the most important material pairings used in mechanical shaft seals for industrial applications: Tungsten carbide/tungsten carbide, silicon carbide/silicon carbide and carbon/tungsten carbide or carbon/silicon carbide.

Tungsten carbide/tungsten carbide (WC/WC)

Cemented tungsten carbide covers the type of hard metals that are based on a hard tungsten carbide (WC) phase and usually a softer metallic binder phase. The correct technical term is cemented tungsten carbide, however, the abbreviated term tungsten carbide (WC) is used for convenience.

Cobalt-bonded (Co) WC is only corrosion resistant in water if the pump incorporates base metal, such as cast iron.

Chromium-nickel-molybdenum-bonded WC has a corrosion resistance equal to EN 14401.

Sintered binderless WC has the highest corrosion resistance. However, its resistance to corrosion in liquids, such as hypochlorite, is not as high. The material pairing WC/WC has the following features:

- Extremely wear resistant
- Very robust, resists rough handling
- Poor dry-running properties. In case of dry-running, the temperature increases to several hundred degrees Celsius in very few minutes and consequently damages the O-rings.

If a certain pressure and a certain temperature are exceeded, the seal may generate noise. Noise is an indication of poor seal operating conditions that in the long term may cause wear of the seal. The limits of use depend on seal face diameter and design.

To a WC/WC seal face pairing, the running-in wear period where noise is to be expected may last 3-4 weeks, although typically, no noise occurs during the first 3-4 days.

Silicon carbide/silicon carbide (SiC/SiC)

Silicon carbide/silicon carbide (SiC/SiC) is an alternative to WC/WC and is used where higher corrosion resistance is required .

The SiC/SiC material pairing has the following features:

- Very brittle material requiring careful handling
- Extremely wear resistant
- Extremely good corrosion resistance. SiC (Q_1^s , Q_1^p and Q_1^g) hardly corrodes, irrespective of the pumped liquid type. However, an exception is water with very poor conductivity, such as demineralised water, which attacks the SiC variants Q_1^s and Q_1^p , whereas Q_1^g is corrosion-resistant also in this liquid
- In general, these material pairings have poor dry-running properties. However, the Q_1^g / Q_1^g material withstands a limited period of dry-running on account of the graphite content of the material

For different purposes, various SiC/SiC variants exist:

Q_1^s , dense-sintered, fine-grained SiC

A direct-sintered, fine-grained SiC with a small amount of tiny pores.

For a number of years, this SiC variant was used as a standard mechanical shaft seal material. Pressure and temperature limits are slightly below those of WC/WC.

Q_1^p , porous, sintered, fine-grained SiC

A variant of the dense-sintered SiC. This SiC variant has large circular closed pores. The degree of porosity is 5-15% and the size of the pores 10-50 $\mu\text{m Ra}$.

The pressure and temperature limits exceed those of WC/WC.

Consequently, in warm water, the Q_1^p / Q_1^p face material pairing generates less noise than the WC/WC pairing. However, noise from porous SiC seals must be expected during the running-in wear period of 3-4 days.

Q_1^g self-lubricating, sintered SiC

Several variants of SiC materials containing dry lubricants are available on the market. The designation Q_1^g applies to a SiC material, which is suitable for use in distilled or demineralised water, as opposed to the above materials.

Pressure and temperature limits of Q_1^g / Q_1^g are similar to those of Q_1^p / Q_1^p .

The dry lubricants, for instance graphite, reduce the friction in case of dry-running, which is of decisive importance to the durability of a seal during dry-running.

Carbon/tungsten carbide or carbon/silicon carbide features

Seals with one carbon seal face have the following features:

- Brittle material requiring careful handling
- Worn by liquids containing solid particles
- Good corrosion resistance
- Good dry-running properties (temporary dry-running)
- The self-lubricating properties of carbon make the seal suitable for use even with poor lubricating conditions (high temperature) without generating noise. However, such conditions will cause wear of the carbon seal face leading to reduced seal life. The wear depends on pressure, temperature, liquid diameter and seal design. Low speeds reduce the lubrication between the seal faces; as a result, increased wear might have been expected. However, this is normally not the case because the distance that the seal faces have to move is reduced.

Section 1.3

Mechanical shaft seals

- Metal-impregnated carbon (A) offers limited corrosion resistance, but improved mechanical strength, heat conductivity and thus reduced wear
- With reduced mechanical strength, but higher corrosion resistance, synthetic resin-impregnated carbon (B) covers a wide application field. Synthetic resin-impregnated carbon is approved for drinking water
- The use of carbon/SiC for hot water applications may cause heavy wear of the SiC, depending on the quality of the carbon and water. This type of wear primarily applies to Q_1^S /carbon. The use of Q_1^P , Q_1^G or a carbon/WC pairing causes far less wear. Thus, carbon/WC, carbon/ Q_1^P or carbon/ Q_1^G are recommended for hot water systems

1.3.5 Factors affecting the seal performance

As mentioned previously, no seal is completely tight. On the next pages, we will present the following factors, which have an impact on the seal performance: Energy consumption, noise and leakage. These factors will be presented individually. However, it is important to stress that they are closely interrelated, and thus must be considered as a whole.

Energy consumption

It comes as no surprise that power is needed to make the seal rotate. The following factors contribute to the power consumption, that is the power loss of a mechanical shaft seal:

- The centrifugal pumping action of the rotating parts. The power consumption increases dramatically with the speed of rotation (to the third power).
- The seal face friction.
 - friction in the thin liquid film and
 - friction due to points of contact between the seal faces.

The level of power consumption depends on seal design, lubricating conditions and seal face materials.

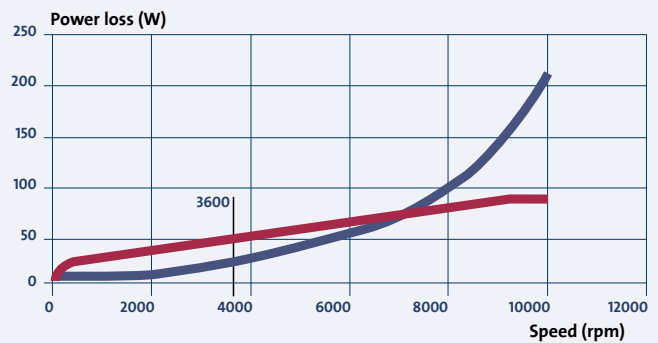


Fig. 1.3.18: Power consumption of a 12 mm mechanical shaft seal

— Pumping action
— Friction

Figure 1.3.18 is a typical example of the power consumption of a mechanical shaft seal. The figure shows that up to 3600 rpm friction is the major reason for the mechanical shaft seal's energy consumption.

Energy consumption is, especially in connection with stuffing boxes, an important issue. As you can tell from the example, replacing a stuffing box by a mechanical shaft seal leads to considerable energy savings, see figure 1.3.19.

Noise

The choice of seal face materials is decisive for the function and the life of the mechanical shaft seal. Noise is generated as a result of the poor lubricating conditions in seals handling low viscosity liquids. The viscosity of water decreases with increasing temperature. This means that the lubricating conditions decrease as the temperature rises. If the pumped liquid reaches or exceeds boiling temperature, the liquid on part of the seal face evaporates, which results in a further decrease in the lubricating conditions. A speed reduction has the same effect, see figure 1.3.20.

Leakage

The pumped liquid lubricates the seal face of a mechanical shaft seal. Thus, better lubrication means less friction and increased leakage. Conversely, less leakage means worse lubricating conditions and increased friction. In practice, the amount of leakage and power loss occurring in mechanical shaft seals can vary. The reason is that leakage depends on factors which are impossible to quantify theoretically because of type of seal faces, type of liquid, spring load, etc. Therefore, figure 1.3.21 should be perceived as a guideline.

To read the leakage rate curve correctly (figure 1.3.21), you have to go through four steps:

Step 1: Read the pressure - in this case 5 bar

Step 2: 30 mm unbalanced shaft seal

Step 3: Speed 3000 rpm

Step 4: Leakage rate 0.06 ml/h



Standard pump 50 mL; 50 mm shaft and 2900 rpm	
Energy consumption	
Stuffing box	2.0 kWh
Mechanical shaft seal	0.3 kWh
Leakage	
Stuffing box	3.0 l/h (when mounted correctly)
Mechanical shaft seal	0.8 ml/h

Fig. 1.3.19: Stuffing box versus mechanical shaft seal

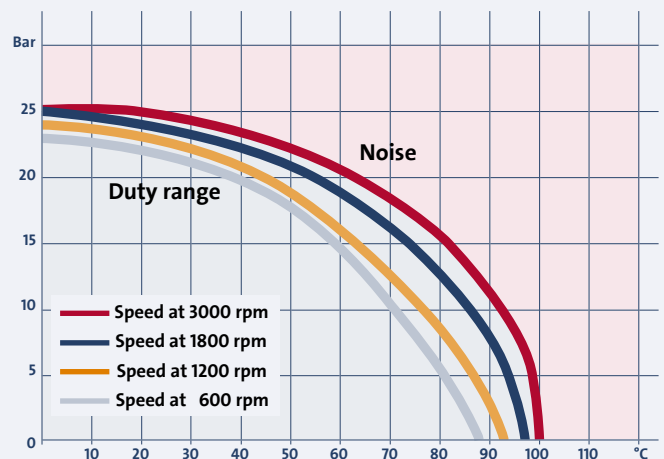


Fig. 1.3.20: Relation between duty range and speed

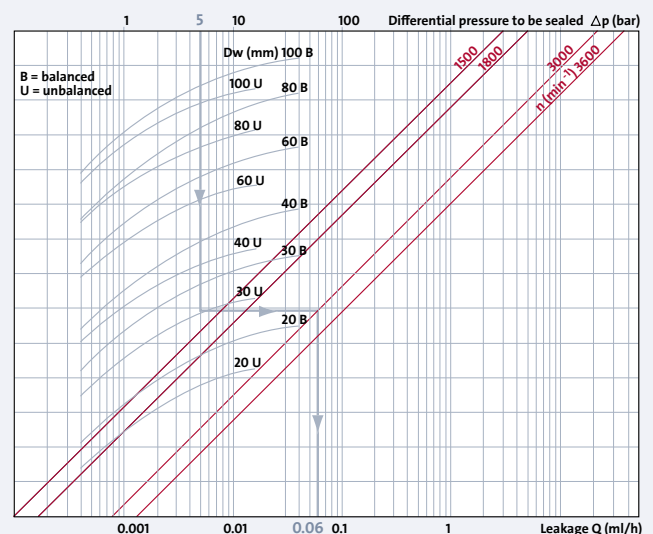


Fig. 1.3.21: Leakage rates

Section 1.4: Motors

- 1.4.1 Standards
- 1.4.2 Motor start-up
- 1.4.3 Voltage supply
- 1.4.4 Frequency converter
- 1.4.5 Motor protection

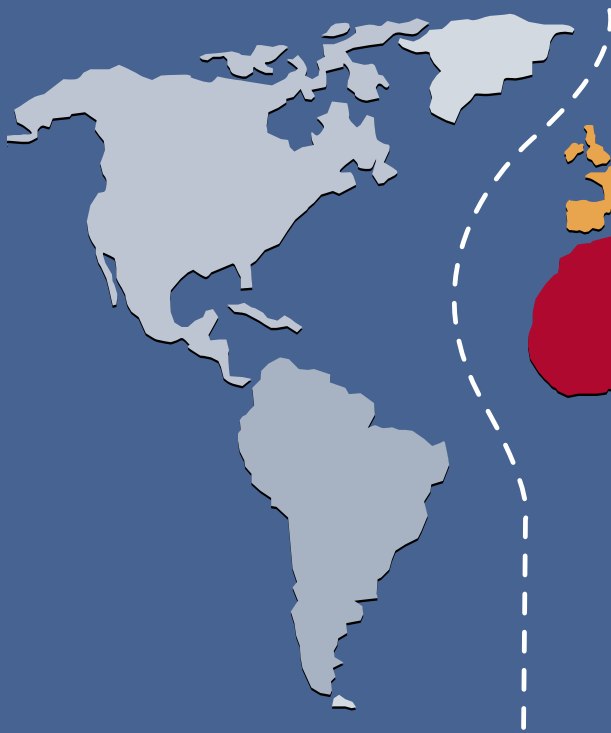


Section 1.4

Motors

Motors are used in many applications all over the world. The purpose of the electric motor is to create rotation, that is to convert electric energy into mechanical energy. Pumps are operated by means of mechanical energy, which is provided by electric motors.

1.4.1 Standards



NEMA

The National Electrical Manufacturers Association (NEMA) sets standards for a wide range of electric products, including motors. NEMA is primarily associated with motors used in North America. The standards represent general industry practices and are supported by the manufacturers of electric equipment. The standards can be found in NEMA Standard Publication No. MG1. Some large motors may not fall under NEMA standards.



Fig. 1.4.1: Electric motor

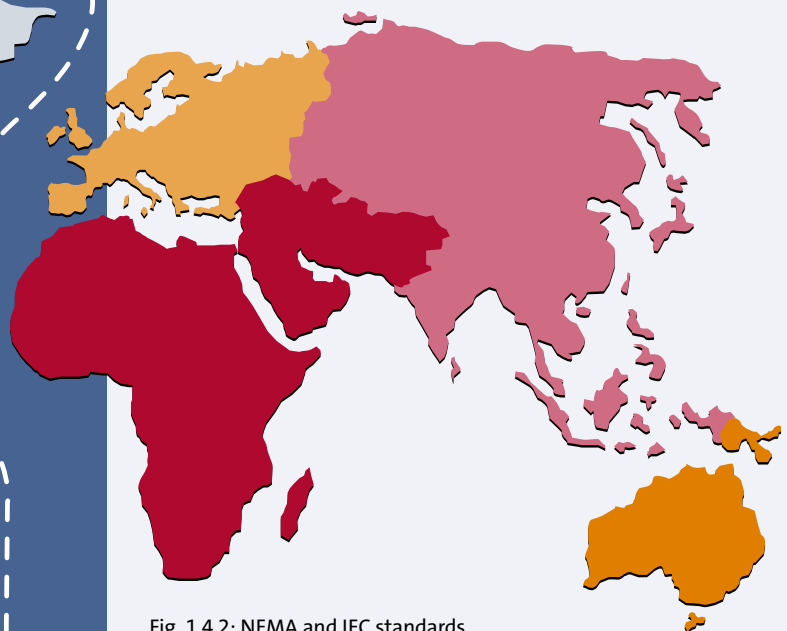


Fig. 1.4.2: NEMA and IEC standards

IEC

The International Electrotechnical Commission (IEC) sets standards for motors used in many countries around the world. The IEC 60034 standard contains recommended electrical practices that have been developed by the participating IEC countries.



Directives and methods of protection – Ex-motors

ATEX (ATmosphère EXplosible) refers to two EU directives about danger of explosion within different areas. The ATEX directive concerns electrical, mechanical, hydraulic and pneumatic equipment. As to the mechanical equipment, the safety requirements in the ATEX directive ensure that pump components, such as shaft seals and bearings do not heat up and ignite gas and dust. The first ATEX directive (94/9/EC) deals with requirements put on equipment for use in areas with danger of explosion. The manufacturer has to fulfil the requirements and mark his products with categories. The second ATEX directive (99/92/EC) deals with the minimum safety and health requirements that the user has to fulfil, when working in areas with danger of explosion. Different techniques are used to prevent electric equipment from becoming a source of ignition. In the case of electric motors, protection types d (flameproof), e (increased safety) and nA (non-sparking) are applied in connection with gas, and DIP (dust ignition proof) is applied in connection with dust.

Flameproof motors - protection type EExd (de)

First of all, flameproof EExd (type de) motors are category 2G equipment for use in zone 1. The stator housing and the flanges enclose the flameproof motor parts that can ignite a potentially explosive atmosphere. Because of the enclosure, the motor can withstand the pressure that goes along with the explosion of an explosive mixture inside the motor. Propagation of the explosion to the atmosphere that surrounds the enclosure is hereby avoided because the explosion is cooled down by means of flame paths. The size of the flame paths is defined in the EN 50018 standard. The surface temperature of the flameproof enclosure should always be in accordance with the temperature classes.

Increased safety motors - protection type EEx (e)

Increased safety motors (type e) are category 2G equipment for use in zone 1. These motors are not flameproof and not built to withstand an internal explosion. The construction of such a motor is based on increased security against

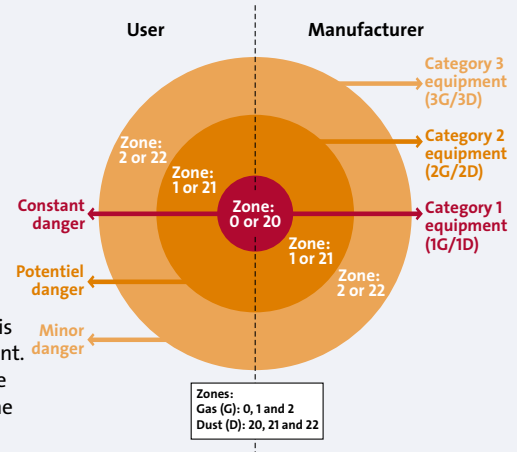


Fig 1.4.3: The link between zones and equipment categories is a minimum requirement. If the national rules are more strict, they are the ones to follow.

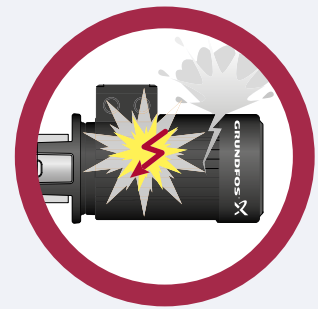


Fig 1.4.4: The explosion occurs inside the motor and is lead out of the motor through the flame paths. The temperature classification for flameproof EExd motors is valid for external surfaces.

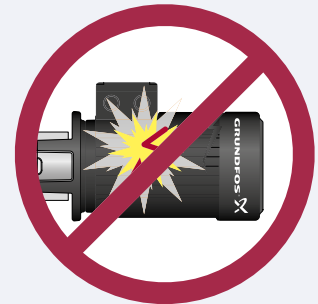


Fig 1.4.5: For increased safety motors EExe, no sparks may occur. The temperature classification covers both internal and external surfaces.



Fig 1.4.6: With non-sparking motors ExnA, no ignition is likely to occur.

Section 1.4

Motors

possible excessive temperatures and occurrence of sparks and arcs during normal operation and when a predictable error occurs. The temperature classification for increased safety motors is valid for both internal and external surfaces, and therefore, it is important to observe the stator winding temperature.

Non-sparking motors - protection type Ex (nA)

Non-sparking motors (type nA) are category 3G equipment for use in zone 2. These motors cannot by any means ignite a potential explosive atmosphere under normal operation, see figure 1.4.6.

Dust Ignition Proof (DIP)

Two types of Dust Ignition Proof motors exist: 2D/category 2 equipment and 3D/category 3 equipment.

2D/category 2 equipment

In order to avoid static electricity to cause ignition, the cooling fan on a category 2 DIP motor for use in zone 21 (area with potential danger of explosion) is made of metal. Likewise, to minimise the risk of ignition, the external ground terminal is subject to more severe demands of construction. The external surface temperature of the enclosure, which is indicated on the motor nameplate and corresponds to the running performance during the worst conditions allowed for the motor. Motors for use in zone 21 (areas with potential danger of explosion) have to be IP65 protected, that is completely protected against dust.

3D/category 3 equipment

The temperature indicated on a category 3 DIP motor for use in zone 22 (areas with minor danger of explosion)

Type of protection	Code	Standards		Use in ATEX category/ Zone	Principle	Application
		CENELEC EN	IEC 60079			
General requirements	-	50014	- 0	-	Basic electrical requirements	All equipment
Oil immersion	o	50015	- 6	Category 2 Zone 1	Electrical components immersed in oil excluding explosive atmosphere from igniting	Transformers
Pressurised	p	50016	- 2	Category 2 Zone 1	Enclosure housing equipment is purged to remove explosive atmosphere and pressurised to prevent ingress of surrounding atmosphere	Switching and control cabinets, large motors
Powder filled	q	50017	- 5	Category 2 Zone 1	Electrical parts are surrounded with power, e.g. quartz to prevent contact with an explosive atmosphere	Electronic devices, e.g. capacitors, fuses
Flameproof	d	50018	- 1	Category 2 Zone 1	Enclosure housing electrical equipment which, if there is an internal explosion, will not ignite surrounding atmosphere	AC motors, control panels, light fittings
Increased safety	e	50019	- 7	Category 2 Zone 1	Additional methods are used to eliminate arcs, sparks and hot surface capable of igniting flammable atmosphere	AC motors, terminal and connection boxes, light fittings, squirrel cage motors
Intrinsic safety	i _a	50020	- 11	Category 1 Zone 0	Electrical energy in equipment is limited so that circuits cannot ignite an atmosphere by sparking or heating	Measurement and control equipment, e.g. sensors, instrumentation
	i _b	50020	- 11	Category 2 Zone 1		
Encapsulation	m	50028	- 18	Category 2 Zone 1	Electrical components embedded in approved material to prevent contact with explosive atmosphere	Measurement and control devices, solenoid valves
Type of protection	nA	50021	- 15	Category 3 Zone 2	Non-arcing and non-sparking	AC motors, terminal boxes, light fittings

Note: Group II Dust atmospheres are covered by CENELEC EN 50281-1-1 and EN 50281-1-2

Fig 1.4.7: Standards and methods of protection



corresponds to the running performance under the worst conditions allowed for that specific motor. A motor for use in zone 22 has to be IP55 protected, that is protected against dust. The IP protection is the only difference between 2D/category 2 equipment and 3D/category 3 equipment.

Mounting (International Mounting - IM)

Three different ways of mounting the motor exist: Foot-mounted motor, flange-mounted motor with free-hole flange (FF) and flange-mounted motor with tapped-hole flange (FT). Figure 1.4.8 shows the different ways of mounting a motor and the standards that apply for the mountings. The mounting of motors is stated according to the following standards:

- IEC 60034-7, Code I, i.e. designation IM followed by the previously used DIN 42590 code
- IEC 60034-7, Code II

Enclosure class (Ingress Protection - IP)

The enclosure class states the degrees of protection of the motor against ingress of solid objects and water. The enclosure class is stated by means of two letters IP followed by two digits, for example IP55. The first digit stands for protection against contact and ingress of solid objects and the second digit stands for protection against ingress of water, see figure 1.4.9.

Drain holes enable the escape of water which has entered the stator housing, for instance through condensation. When the motor is installed in a damp environment, the bottom drain hole should be opened. Opening the drain hole changes the motor's enclosure class from IP55 to IP44.

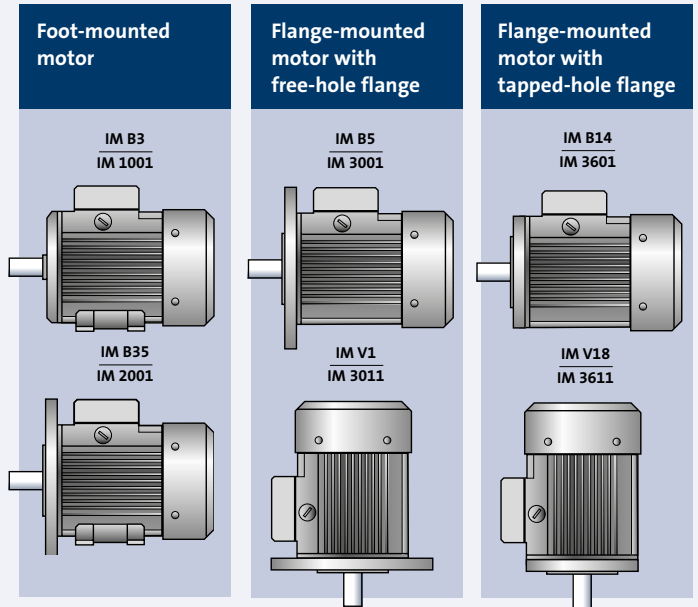


Fig 1.4.8: Different mounting methods

First digit	Second digit
Protection against contact and ingress of solid objects	Protection against ingress of water
0 No special protection	0 No special protection
1 The motor is protected against solid objects bigger than 55 mm, e.g. a hand	1 The motor is protected against vertically falling drops of water, such as condensed water
2 The motor is protected against objects bigger than 12 mm, e.g. a finger	2 The motor is protected against vertically falling drops of water, even if the motor is tilted at an angle of 15°
3 The motor is protected against solid objects bigger than 25 mm, i.e. wires, tools, etc.	3 The motor is protected against water spray falling at an angle of 60° from vertical
4 The motor is protected against solid objects bigger than 1 mm, e.g. wires	4 The motor is protected against water splashing from any direction
5 The motor is protected against ingress of dust	5 The motor is protected against water being projected from a nozzle from any direction
6 The motor is completely dust-proof	6 The motor is protected against heavy seas or high-pressure water jets from any direction
	7 The motor is protected when submerged from 15 cm to 1 m in water for a period specified by the manufacturer
	8 The motor is protected against continuous submersion in water under conditions specified by the manufacturer

Fig 1.4.9: The enclosure class is stated by means of two digits IP followed by two letters; for example IP55

Section 1.4

Motors

Frame size

Figure 1.4.11 gives an overview of the relation between frame size, shaft end, motor power and flange type and size. For motors in frame sizes 63 up to and including 315M, the relationship is specified in EN 50347. For motors with frame size 315L and larger, no standard covers this relation. The figure shows where on the motor the different values that make up the frame size are measured.

Flanges and shaft end comply with EN 50347 and IEC 60072-1. Some pumps have a coupling, which requires a smooth motor shaft end or a special shaft extension which is not defined in the standards.

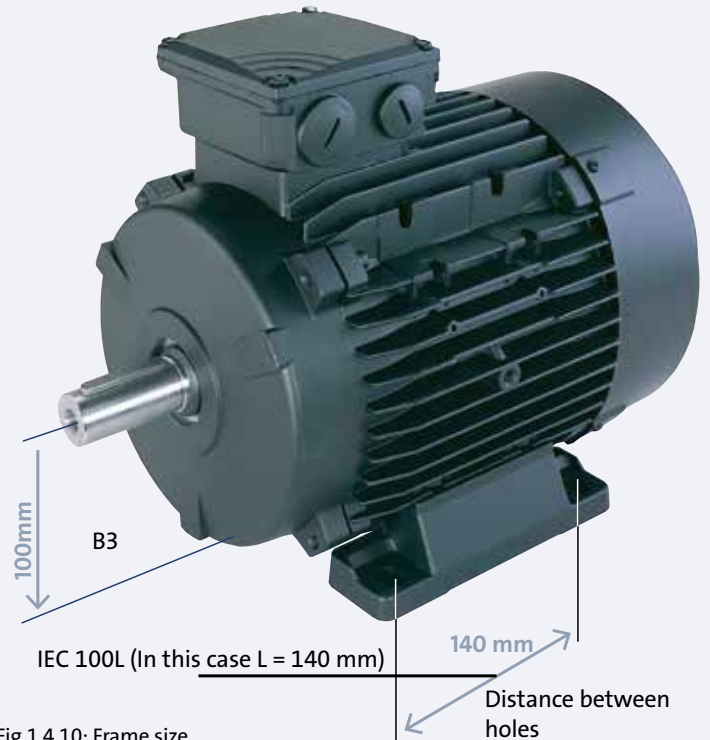
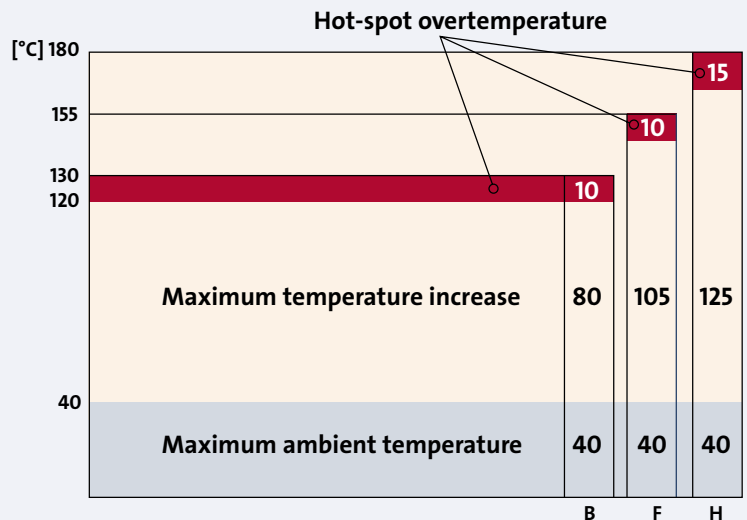


Fig 1.4.10: Frame size

Insulation class

The insulation class is defined in the IEC 60085 standard and tells something about how robust the insulation system is to temperatures. The life of an insulation material is highly dependent on the temperature to which it is exposed. The various insulation materials and systems are classified into insulation classes depending on their ability to resist high temperatures.



Class	Maximum ambient temperature (°C)	Maximum temperature increase (K)	Hot-spot overtemperature (K)	Maximum winding temperature (Tmax) (°C)
B	40	80	10	130
F	40	105	10	155
H	40	125	15	180

Fig 1.4.12: Different insulation classes and their temperature increase at nominal voltage and load



Fig 1.4.11: The relation between frame size and power input

1 Frame size	2 Shaft end diameter		3 Rated power				4 Flange size	
	2-pole	4-, 6-, 8-pole	2-pole	4-pole	6-pole	8-pole	Free-hole flange	Tapped-hole flange
	[mm]	[mm]	[kW]	[kW]	[kW]	[kW]	(FF)	(FT)
56	9	9	0.09; 0.12	0.06; 0.09			FF100	FT65
63	11	11	0.18; 0.25	0.12 ; 0.18			FF115	FT75
71	14	14	0.37; 0.55	0.25; 0.37			FF130	FT85
80	19	19	0.75; 1.1	0.55; 0.75	0.37; 0.55		FF165	FT100
90S	24	24	1.5	1.1	0.75	0.37	FF165	FT115
90L	24	24	2.2	1.5	1.1	0.55	FF165	FT115
100L	28	28	3	2.2; 3	1.5	0.75; 1.1	FF215	FT130
112M	28	28	4	4	2.2	1.5	FF215	FT130
132S	38	38	5.5; 7.5	5.5	3	2.2	FF265	FT165
132M	38	38	-	7.5	4; 5.5	3	FF265	FT165
160M	42	42	11; 15	11	7.5	4; 5.5	FF300	FT215
160L	42	42	18.5	15	11	7.5	FF300	FT215
180M	48	48	22	18.5	-	-	FF300	
180L	48	48	-	22	15	11	FF300	
200L	55	55	30; 37	30	18.5; 22	15	FF350	
225S	55	60	-	37	30	18.5	FF400	
225M	55	60	45	45	-	22	FF400	
250M	60	65	55	55	37	30	FF500	
280S	65	75	75	75	45	37	FF500	
280M	65	75	90	90	55	45	FF500	
315S	65	80	110	110	75	55	FF600	
315M	65	80	132	132	90	75	FF600	
315L	65	80	160; 200; 250				FF600	
355	75	100	315; 355; 400; 450; 500	315; 355; 400; 450; 500			FF740	
400	80	100	560; 630; 710	560; 630; 710			FF840	
450	90	120	800; 900; 1000	800; 900; 1000			FF940	

1.4.2 Motor start-up

We distinguish between different ways of starting up the motor: Direct-on-line starting, star/delta starting, autotransformer starting, soft starter and frequency converter starting. Each of these methods have their pros and cons, see figure 1.4.13.

Fig 1.4.13: Starting method

Starting method	Pros	Cons
Direct-on-line starting (DOL)	Simple and cost-efficient. Safe starting.	High locked-rotor current.
Star/delta starting (SD) (Y/Δ)	Reduction of starting current by factor 3.	Current pulses when switching over from star to delta. Not suitable if the load has a low inertia. Reduced locked-rotor torque.
Autotransformer starting	Reduction of locked-rotor current and torque.	Current pulses when switching from reduced to full voltage. Reduced locked-rotor torque.
Soft starter	"Soft" starting. No current pulses. Less water hammer when starting a pump. Reduction of locked-rotor current as required, typically 2-3 times.	Reduced locked-rotor torque.
Frequency converter starting	No current pulses. Less water hammer when starting a pump. Reduction of locked-rotor current as required, typically 2 to 3 times. Can be used for continuous feeding of the motor.	Reduced locked-rotor torque. Expensive

Direct-on-line starting (DOL)

As the name suggests, direct-on-line starting means that the motor is started by connecting it directly to the supply at rated voltage. Direct-on-line starting is suitable for stable supplies and mechanically stiff and well-dimensioned shaft systems, for example pumps. Whenever applying the direct-on-line starting method, it is important to consult local authorities.

Star/delta starting

The objective of this starting method, which is used with three-phase induction motors, is to reduce the starting current. In one position, current supply to the stator windings is connected in star (Y) for starting. In other positions, current supply is reconnected to the windings in delta (Δ) once the motor has gained speed.

Autotransformer starting

As the name states, autotransformer starting makes use of an autotransformer. The autotransformer is placed in series with the motor during start and varies the voltage up to nominal voltage in two to four steps.

Soft starter

A soft starter is, as you would expect, a device which ensures a soft start of a motor. This is done by raising the voltage to a preset voltage raise time.

Frequency converter starting

Frequency converters are designed for continuous feeding of motors, but they can also be used for soft starting.



1.4.3 Voltage supply

The motor's rated voltage lies within a certain voltage range. Figure 1.4.14 shows typical voltage examples for 50 Hz and 60 Hz motors.

According to the international standard IEC 60038, the motor has to be able to operate with a main voltage tolerance of $\pm 10\%$.

For motors that are designed according to the IEC 60034-1 standard with a wide voltage range, e.g. 380-415 V, the main voltage may have a tolerance of $\pm 5\%$.

The permissible maximum temperature for the actual insulation class is not exceeded when the motor is operated within the rated voltage range. For conditions at the extreme boundaries the temperature typically rises approx. 10 Kelvin.

1.4.4 Frequency converter

Frequency converters are often used for speed controlling pumps, see chapter 4. The frequency converter converts the mains voltage into a new voltage and frequency, causing the motor to run at a different speed. This way of regulating the frequency might result in some problems:

- Acoustic noise from the motor, which is sometimes transmitted to the system as disturbing noise
- High voltage peaks on the output from the frequency converter to the motor

Typical voltage examples	
50 Hz	
50 Hz motors come with the following voltages:	
<ul style="list-style-type: none"> • 3 x 220 – 240 Δ / 380 – 415 Y • 3 x 200 – 220 Δ / 346 – 380 Y • 3 x 200 Δ / 346 Y • 3 x 380 – 415 Δ • 1 x 220 – 230 / 240 	
60 Hz	
60 Hz motors come with the following voltages:	
<ul style="list-style-type: none"> • 3 x 200 – 230 Δ / 346 – 400 Y • 3 x 220 – 255 Δ / 380 – 440 Y • 3 x 220 – 277 Δ / 380 – 480 Y • 3 x 200 – 230 Δ / 346 – 400 Y • 3 x 380 – 480 Δ 	

Fig 1.4.14: Typical voltages

Mains voltage according to IEC 60038	
50 ̳	60 ̳
230 V $\pm 10\%$	–
400 V $\pm 10\%$	–
690 V $\pm 10\%$	–
–	460 V $\pm 10\%$

Fig 1.4.15: Mains voltage according to IEC 60038

Insulation for motors with frequency converter

In connection with motors with frequency converters we distinguish between different kinds of motors, with different kinds of insulation.

Motors without phase insulation

For motors constructed without the use of phase insulation, continuous voltages (RMS) above 460 V can increase the risk of disruptive discharges in the windings and thus destruction of the motor. This applies to all motors constructed according to these principles. Continuous operation with voltage peaks above 650 V can cause damage to the motor.

Motors with phase insulation

In three-phase motors, phase insulation is normally used and consequently, specific precautions are not necessary if the voltage supply is smaller than 500 V.

Motors with reinforced insulation

In connection with supply voltages between 500 V and 690 V, the motor has to have reinforced insulation or be protected with delta U /delta t filters. For supply voltages of 690 V and higher, the motor has to be fitted with both reinforced insulation and delta U /delta t filters.

Motors with insulated bearings

In order to avoid harmful current flows through the bearings, the motor bearings have to be electrically insulated. This applies for motors from frame size 280 and up.

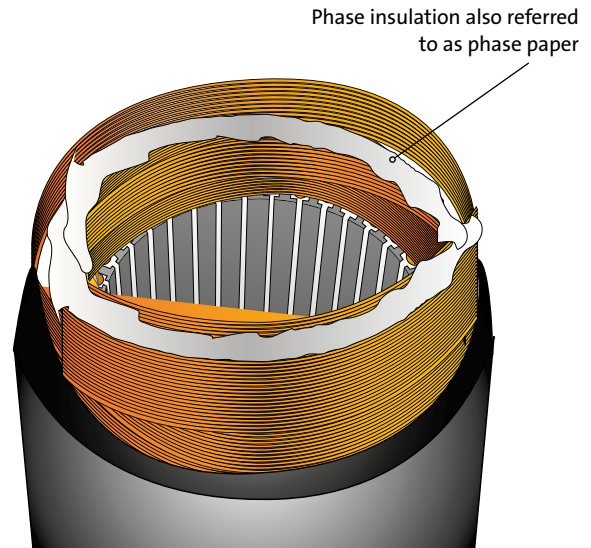


Fig 1.4.16: Stator with phase insulation



Motor efficiency

Generally speaking, electric motors are quite efficient. Some motors have electricity-to-shaft power efficiencies of 80-93% depending on the motor size and sometimes even higher for bigger motors. Two types of energy losses in electric motors exist: Load-dependent losses and load-independent losses.

Load-dependent losses vary with the square of the current and cover:

- Stator winding losses (copper losses)
- Rotor losses (slip losses)
- Stray losses (in different parts of the motor)

Load-independent losses in the motor refer to:

- Iron losses (core losses)
- Mechanical losses (friction)

Different motor classifications categorise motors according to efficiency. The most important are CEMEP in the EU (EFF1, EFF2 and EFF3) and EPart in the US.

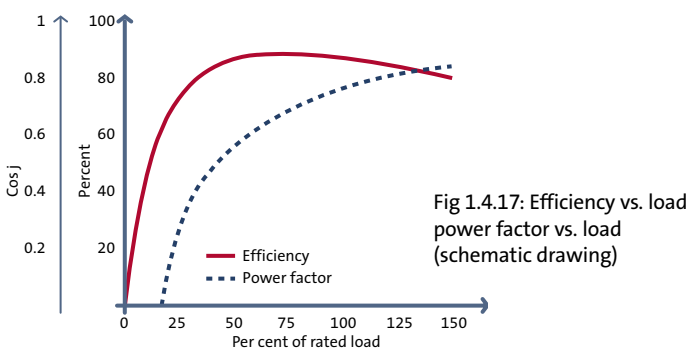


Fig 1.4.17: Efficiency vs. load power factor vs. load (schematic drawing)

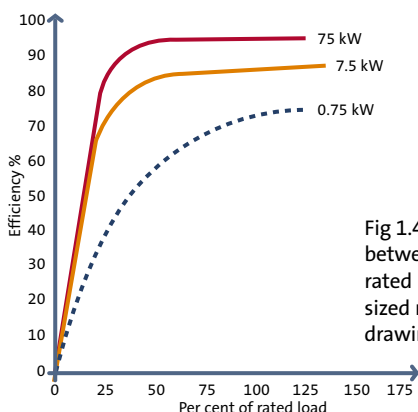


Fig 1.4.18: The relation between efficiency and rated load of different sized motors (schematic drawing)

Motors can fail because of overload for a longer period of time and therefore most motors are intentionally oversized and only operate at 75% to 80% of their full load capacity. At this level of loading, motor efficiency and power factor remain relatively high. But when the motor load is less than 25%, the efficiency and the power factor decrease.

The motor efficiency drops quickly below a certain percentage of the rated load. Therefore, it is important to size the motor so that the losses associated with running the motor too far below its rated capacity are minimised. It is common to choose a pump motor that meets the power requirements of the pump.

1.4.5 Motor protection

Motors are nearly always protected against reaching temperatures, which can damage the insulation system. Depending on the construction of the motor and the application, thermal protection can also have other functions, e.g. prevent damaging temperatures in the frequency converter if it is mounted on the motor.

The type of thermal protection varies with the motor type. The construction of the motor together with the power consumption must be taken into consideration when choosing thermal protection. Generally speaking, motors have to be protected against the following conditions:

Errors causing slow temperature increases in the windings:

- Slow overload
- Long start-up periods
- Reduced cooling / lack of cooling
- Increased ambient temperature
- Frequent starts and stops
- Frequency fluctuation
- Voltage fluctuation

Errors causing fast temperature increases in the windings:

- Blocked rotor
- Phase failure

Thermal protection (TP)

According to the IEC 60034-11 standard, the thermal protection of the motor has to be indicated on the nameplate with a TP designation. Figure 1.4.19 shows an overview of the TP designations.

Symbol	Technical overload with variation (1 digit)	Number of levels and function area (2 digits)	Category 1 (3 digits)
TP 111	Only slow (i.e. constant overload)	1 level at cutoff	1
TP 112			2
TP 121		2 levels at emergency signal and cutoff	1
TP 122			2
TP 211	Slow and fast (i.e. constant overload and blocked condition)	1 level at cutoff	1
TP 212			2
TP 221		2 levels at emergency signal and cutoff	1
TP 222			2
TP 311	Only fast (i.e. blocked condition)	1 level at cutoff	1
TP 312			2

Indication of the permissible temperature level when the motor is exposed to thermal overload. Category 2 allows higher temperatures than category 1 does.

Fig 1.4.19: TP designations

PTC thermistors

PTC thermistors (Positive Temperature Coefficient Thermistors) can be fitted into the windings of a motor during production or retrofitted afterwards. Usually 3 PTCs are fitted in series; 1 in each phase of the winding. They can be purchased with trip temperatures ranging from 90°C to 180°C in 5 degrees steps. PTCs have to be connected to a thermistor relay, which detects the rapid increase in resistance of the thermistor when it reaches its trip temperature. These devices are non-linear. At ambient temperatures the resistance of a set of 3 will be about 200-300 ohms and this will increase rapidly when the thermistor reaches its trip temperature. If the temperature increases any further, the PTC thermistor can reach several thousand ohms. The thermistor relays are usually set to trip at 3000 ohms or are preset to trip according to what the DIN 44082 standard prescribes. The TP designation for PTCs for motors smaller than 11 kW is TP 211 if the PTCs are fitted into the windings. If the PTCs are retrofitted the TP designation is TP 111. The TP designation for PTCs for motors larger than 11 kW is normally TP 111.

Thermal switch and thermostats

Thermal switches are small bi-metallic switches that switch due to the temperature. They are available with a wide range of trip temperatures; normally open and closed types. The most common type is the closed one. One or two, in series, are usually fitted in the windings like thermistors and can be connected directly to the circuit of the main contactor coil. In that way no relay is necessary. This type of protection is cheaper than thermistors, but on the other hand, it is less sensitive and is not able to detect a locked rotor failure.

Thermal switches are also referred to as Thermik, Klixon switches and PTO (Protection Thermique à Ouverture). Thermal switches always carry a TP111 designation.

Single-phase motors

Single-phase motors normally come with incorporated thermal protection. Thermal protection usually has an automatic reclosing. This implies that the motor has to be connected to the mains in a way that ensures that accidents caused by the automatic reclosing are avoided.

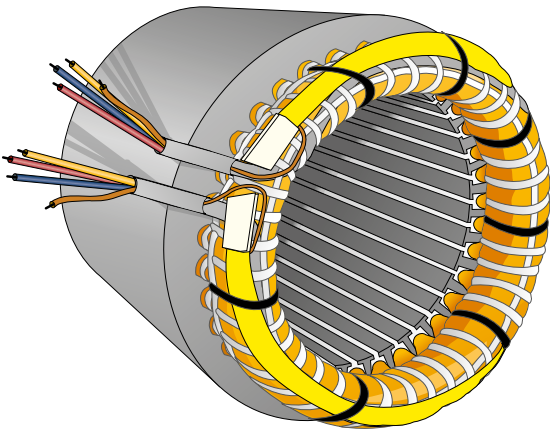
Three-phase motors

Three-phase motors have to be protected according to local regulations. This kind of motor has usually incorporated contacts for resetting in the external control circuit.



Standstill heating

A heating element ensures the standstill heating of the motor. The heating element is especially used in connection with applications that struggle with humidity and condensation. By using the standstill heating, the motor is warmer than the surroundings and thereby, the relative air humidity inside the motor is always lower than 100%.



1.4.20: Stator with heating element

Maintenance

The motor should be checked at regular intervals. It is important to keep the motor clean in order to ensure adequate ventilation. If the pump is installed in a dusty environment, the pump must be cleaned and checked regularly.

Bearings

Normally, motors have a locked bearing in the drive end and a bearing with axial play in the non-drive end. Axial play is required due to production tolerances, thermal expansion during operation, etc. The motor bearings are held in place by wave spring washers in the non-drive end, see figure 1.4.21.

The fixed bearing in the drive end can be either a deep-groove ball bearing or an angular contact bearing.

Bearing clearances and tolerances are stated according to ISO 15 and ISO 492. Because bearing manufacturers have to fulfil these standards, bearings are internationally interchangeable.

In order to rotate freely, a ball bearing must have a certain internal clearance between the raceway and the balls. Without this internal clearance, the bearings can either be difficult to rotate or it may even seize up and be unable to rotate. On the other hand, too much internal clearance will result in an unstable bearing that may generate excessive noise or allow the shaft to wobble.

Depending on which pump type the motor is fitted, the deep-groove ball bearing in the drive end must have C3 or C4 clearance. Bearings with C4 clearance are less heat sensitive and have increased axial load-carrying capacity.

The bearing carrying the axial forces of the pump can have C3 clearance if:

- the pump has complete or partial hydraulic relief
- the pump has many brief periods of operation
- the pump has long idle periods

C4 bearings are used for pumps with fluctuating high axial forces. Angular contact bearings are used if the pump exerts strong one-way axial forces.

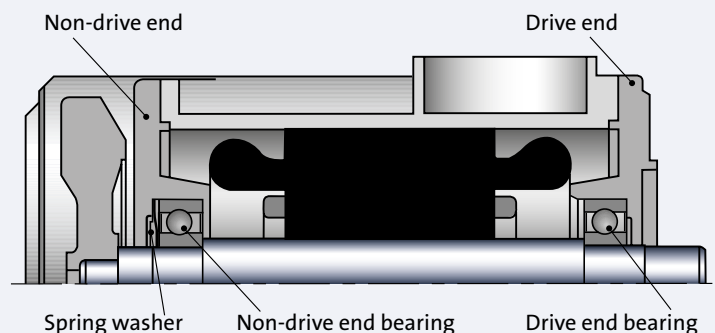


Fig 1.4.21: Cross-sectional drawing of motor

Section 1.4

Motors

Axial forces	Bearing types and recommended clearance	
	Drive end	Non-drive end
Moderate to strong forces. Primarily outward pull on the shaft end	Fixed deep-groove ball bearing (C4)	Deep-groove ball bearing (C3)
Strong outward pull on the shaft end	Fixed angular contact bearing	Deep-groove ball bearing (C3)
Moderate forces. Primarily outward pull on the shaft end (partly hydraulically relieved in the pump)	Fixed deep-groove ball bearing (C3)	Deep-groove ball bearing (C3)
Small forces (flexible coupling)	Fixed deep-groove ball bearing (C3)	Deep-groove ball bearing (C3)
Strong inward pressure	Deep-groove ball bearing (C4)	Fixed angular contact bearing (C4)

Fig:1.4.22: Typical types of bearings in pump motors

Motors with permanently lubricated bearings

For closed permanently lubricated bearings, use one of the following high temperature resistant types of grease:

- Lithium-based grease
- Polyurea-based grease

The technical specifications must correspond to the standard DIN - 51825 K2 or better. The basic oil viscosity must be higher than:

- 50 cSt ($10^{-6}\text{m}^2/\text{sec}$) at 40°C and
- 8 cSt (mm^2/sec) at 100°C

For example Klüberquiet BQH 72-102 with a grease filling ratio of: 30 - 40%.

Motors with lubrication system

Normally, frame size 160 motors and upwards have lubricating nipples for the bearings both in the drive end and the non-drive end.

The lubricating nipples are visible and easily accessible. The motor is designed in such a way that:

- there is a flow of grease around the bearing
- new grease enters the bearing
- old grease is removed from the bearing

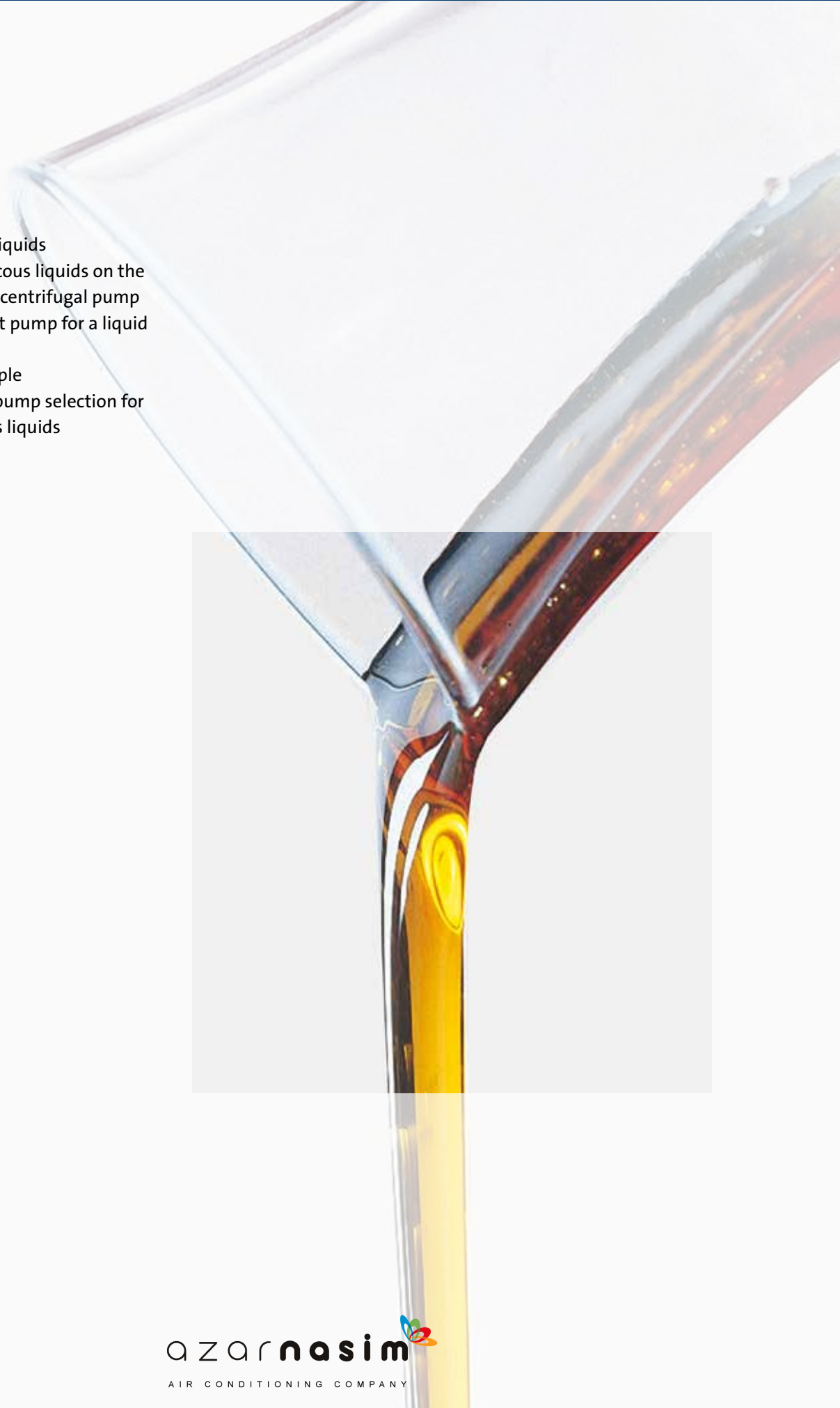
Motors with lubricating systems are supplied with a lubricating instruction, for instance as a label on the fan cover. Apart from that, instructions are given in the installation and operating instructions.

The lubricant is often lithium-based, high temperature grease, for instance EXXON UNIREX N3 or Shell Alvania Grease G3. The basic oil viscosity must be

- higher than 50 cSt ($10^{-6}\text{m}^2/\text{sec}$) at 40°C and
- 8 cSt (mm^2/sec) at 100°C

Section 1.5: Liquids

- 1.5.1 Viscous liquids
- 1.5.2 Non-Newtonian liquids
- 1.5.3 The impact of viscous liquids on the performance of a centrifugal pump
- 1.5.4 Selecting the right pump for a liquid with antifreeze
- 1.5.5 Calculation example
- 1.5.6 Computer-aided pump selection for dense and viscous liquids



Section 1.5

Liquids

1.5.1 Viscous liquids

There is no doubt about it; water is the most common liquid that pumps handle. However, in a number of applications, pumps have to handle other types of liquids, e.g. oil, propylene glycol, gasoline. Compared to water, these types of liquids have different density and viscosity.

Viscosity is a measure of the thickness of the liquid.

The higher the viscosity, the thicker the liquid. Propylene glycol and motor oil are examples of thick or high viscous liquids. Gasoline and water are examples of thin, low viscous liquids.

Two kinds of viscosity exist:

- The dynamic viscosity (μ), which is normally measured in Pa·s or Poise. (1 Poise = 0.1 Pa·s)
- The kinematic viscosity (ν), which is normally measured in centiStokes or m^2/s (1 cSt = $10^{-6} m^2/s$)

The relation between the dynamic viscosity (μ) and the kinematic viscosity (ν) is shown in the formula on your right hand side.

On the following pages, we will only focus on kinematic viscosity (ν).

The viscosity of a liquid changes considerably with the change in temperature; hot oil is thinner than cold oil. As you can tell from figure 1.5.1, a 50% propylene glycol liquid increases its viscosity 10 times when the temperature changes from +20 to -20°C.

For more information concerning liquid viscosity, go to appendix L.

$$\nu = \frac{\mu}{\rho}$$

ρ = density of liquid

Liquid	Liquid temperature t [°C]	Density ρ [kg/m ³]	Kinematic viscosity ν [cSt]
Water	20	998	1.004
Gasoline	20	733	0.75
Olive oil	20	900	93
50% Propylene glycol	20	1043	6.4
50% Propylene glycol	-20	1061	68.7

Fig. 1.5.1: Comparison of viscosity values for water and a few other liquids. Density values and temperatures are also shown



1.5.2 Non-Newtonian liquids

The liquids discussed so far are referred to as Newtonian fluids. The viscosity of Newtonian liquids is not affected by the magnitude and the motion that they are exposed to. Mineral oil and water are typical examples of this type of liquid. On the other hand, the viscosity of non-Newtonian liquids does change when agitated.

This calls for a few examples:

- Dilatant liquids like cream – the viscosity increases when agitated
- Plastic fluids like ketchup – have a yield value, which has to be exceeded before flow starts. From that point on, the viscosity decreases with an increase in agitation
- Thixotropic liquids like non-drip paint - exhibit a decreasing viscosity with an increase in agitation

The non-Newtonian liquids are not covered by the viscosity formula described earlier in this section.

1.5.3 The impact of viscous liquids on the performance of a centrifugal pump

Viscous liquids, that is liquids with higher viscosity and/or higher density than water, affect the performance of centrifugal pumps in different ways:

- Power consumption increases, i.e. a larger motor may be required to perform the same task
- Head, flow rate and pump efficiency are reduced

Let us have a look at an example. A pump is used for pumping a liquid in a cooling system with a liquid temperature below 0°C. To avoid that the liquid freezes, an antifreeze agent like propylene glycol is added to the water. When glycol or a similar antifreeze agent is added to the pumped liquid, the liquid obtains properties,

different from those of water. The liquid will have:

- Lower freezing point, t_f [°C]
- Lower specific heat, c_p [kJ/kg·K]
- Lower thermal conductivity, λ [W/m·K]
- Higher boiling point, t_b [°C]
- Higher coefficient of expansion, β [m/°C]
- Higher density, ρ [kg/m³]
- Higher kinematic viscosity, ν [cSt]

These properties have to be kept in mind when designing a system and selecting pumps. As mentioned earlier, the higher density requires increased motor power and the higher viscosity reduces pump head, flow rate and efficiency resulting in a need for increased motor power, see figure 1.5.2.

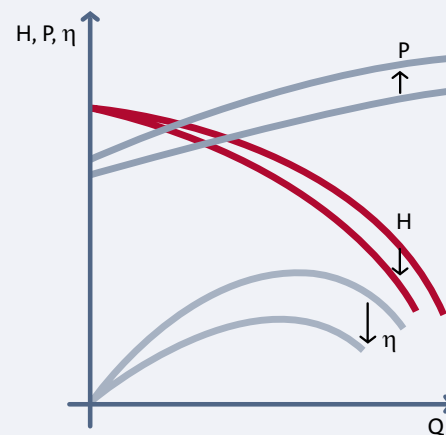


Fig. 1.5.2: Changed head, efficiency and power input for liquid with higher viscosity

1.5.4 Selecting the right pump for a liquid with antifreeze

Pump characteristics are usually based on water at around 20°C, i.e. a kinematic viscosity of approximately 1 cSt and a density of approximately 1,000 kg/m³. When pumps are used for liquids containing antifreeze below 0°C, it is necessary to examine whether the pump can supply the required performance or whether a larger motor is required. The following section presents a simplified method used to determine pump curve corrections for pumps in systems that have to handle a viscosity between 5 - 100 cSt and a density of maximum 1,300 kg/m³. Please notice that this method is not as precise as the computer-aided method described later in this section.

Pump curve corrections for pumps handling high viscous liquid

Based on knowledge about required duty point, Q_s , H_s , and kinematic viscosity of the pumped liquid, the correction factors of H and P_2 can be found, see figure 1.5.3.

To get the correction factor for multistage pumps, the head of one stage has to be used.

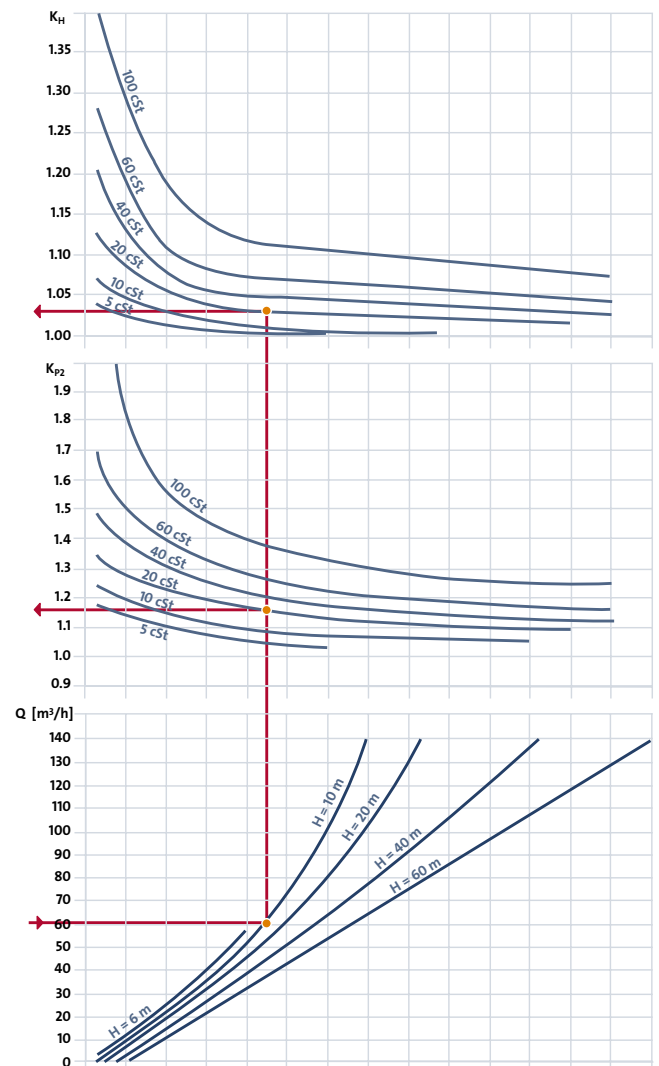


Fig. 1.5.3: It is possible to determine the correction factor for head and power consumption at different flow, head and viscosity values



Figure 1.5.3 is read in the following way:

When k_H and k_{p2} are found in the figure, the equivalent head for clean water H_W and the corrected actual shaft power P_{2s} can be calculated by the following formula

$$H_W = k_H \cdot H_S$$

$$P_{2s} = k_{p2} \cdot P_{2w} \cdot \left(\frac{\rho_s}{\rho_w} \right)$$

where

H_W : is the equivalent head of the pump if the pumped liquid is “clean” water

P_{2w} : is the shaft power at the duty point (Q_s, H_w) when the pumped liquid is water

H_S : is the desired head of the pumped liquid (with agents)

P_{2s} : is the shaft power at the duty point (Q_s, H_s) when the pumped liquid is water (with agents)

ρ_s : is the density of the pumped liquid

ρ_w : is the density of water = 998 kg/m³

The pump selection is based on the normal data sheets/ curves applying to water. The pump should cover the duty point $Q, H = Q_s, H_w$, and the motor should be powerful enough to handle P_{2s} on the shaft.

Figure 1.5.4 shows how to proceed when selecting a pump and testing whether the motor is within the power range allowed.

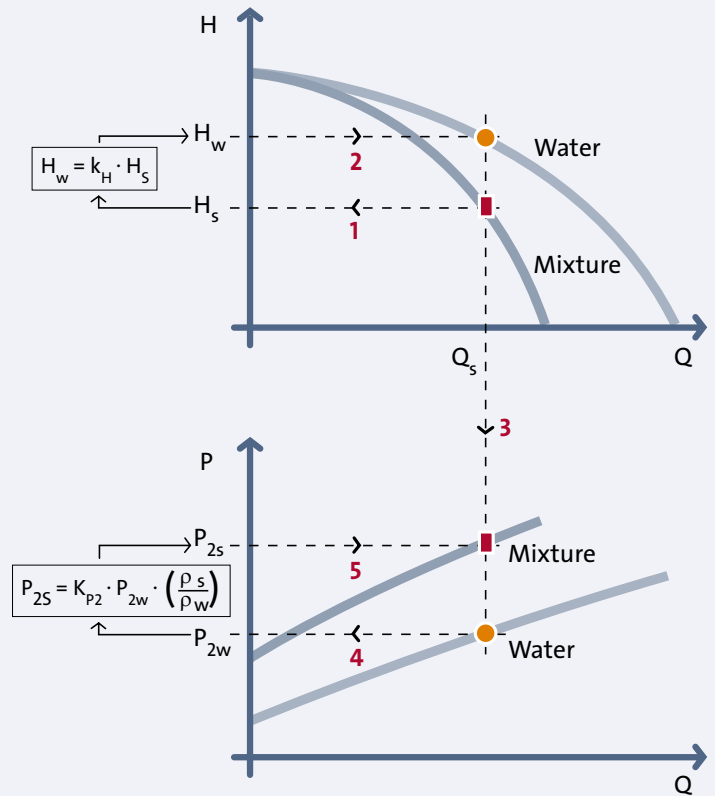


Fig. 1.5.4: Pump curve correction when choosing the right pump for the system

The pump and motor selecting procedure contains the following steps:

- Calculate the corrected head H_w (based on H_s and k_H), see figure 1.5.4 **1-2**
- Choose a pump capable of providing performance according to the corrected duty point (Q_s, H_w)
- Read the power input P_{2w} in the duty point (Q_s, H_w), see figure 1.5.4 **3-4**
- Based on P_{2w} , k_{p2} , ρ_w , and ρ_s calculate the corrected required shaft power P_{2s} , see figure 1.5.4 **4-5**
- Check if $P_{2s} < P_{2,MAX}$ of the motor. If that is the case the motor can be used. Otherwise select a more powerful motor

1.5.5 Calculation example

A circulator pump in a refrigeration system is to pump a 40% (weight) propylene glycol liquid at -10°C . The desired flow is $Q_s = 60 \text{ m}^3/\text{h}$, and the desired head is $H_s = 12 \text{ m}$. Knowing the required duty point, it is possible to find the QH-characteristic for water and choose a pump able to cover the duty point. Once we have determined the needed pump type and size we can check if the pump is fitted with a motor, which can handle the specific pump load.

The liquid has a kinematic viscosity of 20 cSt and a density of 1049 kg/m^3 . With $Q_s = 60 \text{ m}^3/\text{h}$, $H_s = 12 \text{ m}$ and $\nu = 20 \text{ cSt}$, the correction factors can be found in figure 1.5.3.

$$k_H = 1.03$$

$$k_{P_2} = 1.15$$

$$H_w = k_H \cdot H_s = 1.03 \cdot 12 = 12.4 \text{ m}$$

$$Q_s = 60 \text{ m}^3/\text{h}$$

The pump has to be able to cover a duty point equivalent to $Q, H = 60 \text{ m}^3/\text{h}, 12.4 \text{ m}$. Once the necessary pump size is determined, the P_2 value for the duty point is found, which in this case is $P_{2w} = 2.9 \text{ kW}$. It is now possible to calculate the required motor power for propylene glycol mixture:

$$P_{2s} = k_{P_2} \cdot P_{2w} \cdot \frac{\rho_s}{\rho_w}$$

$$P_{2s} = 1.15 \cdot 2.9 \cdot \frac{1049}{998} = 3.5 \text{ kW}$$

The calculation shows that the pump has to be fitted with a 4 kW motor, which is the smallest motor size able to cover the calculated $P_{2s} = 3.5 \text{ kW}$.

1.5.6 Computer-aided pump selection for dense and viscous liquids

Some computer-aided pump selection tools include a feature that compensates for the pump performance curves based on input of the liquid density and viscosity. Figure 1.5.5 shows the pump performance curves from the example we just went through.

The figure shows both the performance curves for the pump when it handles viscous liquid (the full lines) and the performance curves when it handles water (the broken lines). As indicated, head, flow and efficiency are reduced, resulting in an increase in power consumption. The value of P_2 is 3.4 kW, which corresponds to the result we got in the calculation example in section 1.5.4.

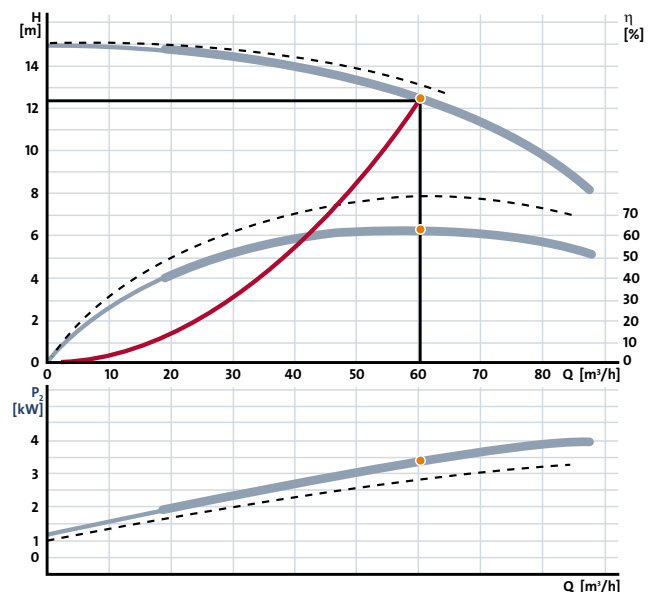


Fig. 1.5.5: Pump performance curves

Section 1.6: Materials

- 1.6.1 What is corrosion?
- 1.6.2 Types of corrosion
- 1.6.3 Metal and metal alloys
- 1.6.4 Ceramics
- 1.6.5 Plastics
- 1.6.6 Rubber
- 1.6.7 Coatings



Section 1.6

Materials

In this section you can read about different materials that are used for pump construction. Our main focus will be on the features that every single metal and metal alloy have to offer. But before we dig any further into the world of materials, we will have a closer look at corrosion. Besides explaining what corrosion is, we will examine the different types of corrosion and what can be done to prevent corrosion from occurring.

1.6.1 What is corrosion?

Corrosion is usually referred to as the degradation of the metal by chemical or electrochemical reaction with its environment, see figure 1.6.1. Considered broadly, corrosion may be looked upon as the tendency of the metal to revert to its natural state similar to the oxide from which it was originally melted. Only precious metals, such as gold and platinum are found in nature in their metallic state.

Some metals produce a tight protective oxide layer on the surface, which hinders further corrosion. If the surface layer is broken it is self-healing. These metals are passivated. Under atmospheric conditions the corrosion products of zinc and aluminium form a fairly tight layer and further corrosion is prevented.

Likewise, on the surface of stainless steel a tight layer of iron and chromium oxide is formed and on the surface of titanium a layer of titanium oxide is formed. The protective layer of these metals explains their good corrosion resistance. Rust, on the other hand, is a non-protective corrosion product on steel.

Rust is porous, not firmly adherent and does not prevent continued corrosion, see figure 1.6.2.

Environmental variables that affect the corrosion resistance of metals and alloys
pH (acidity)
Oxidizing agents (such as oxygen)
Temperature
Concentration of solution constituents (such as chlorides)
Biological activity
Operating conditions (such as velocity, cleaning procedures and shutdowns)

Fig. 1.6.1: Environmental variables that affect the corrosion resistance of metals and alloys

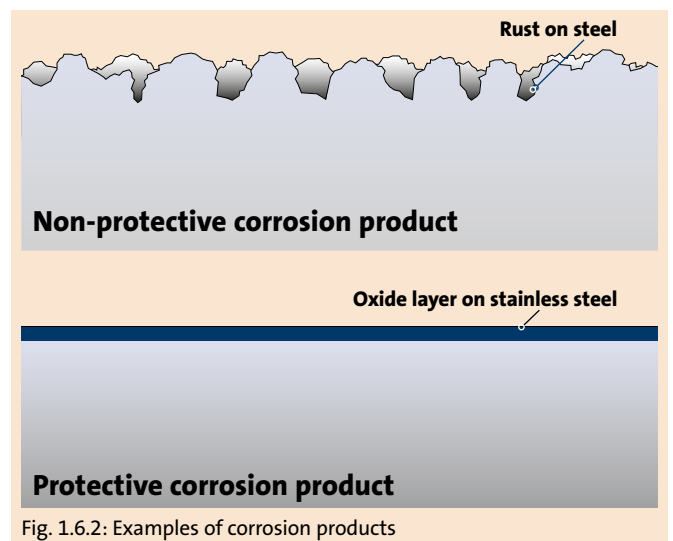


Fig. 1.6.2: Examples of corrosion products



1.6.2 Types of corrosion

Generally, metallic corrosion involves the loss of metal at a spot on an exposed surface. Corrosion occurs in various forms ranging from uniform attacks over the entire surface to severe local attacks.

The environment's chemical and physical conditions determine both the type and the rate of corrosion attacks. The conditions also determine the type of corrosion products that are formed and the control measures that need to be taken. In many cases, it is impossible or rather expensive to completely stop the corrosion process; however, it is usually possible to control the process to acceptable levels.

On the following pages we will go through the different forms of corrosion in order to give you an idea of their characteristics.

Uniform corrosion

Uniform or general corrosion is characterised by corrosive attacks proceeding evenly over the entire surface, or on a large part of the total area. General thinning continues until the metal is broken down. Uniform corrosion is the type of corrosion where the largest amount of metal is wasted.

Examples of metals, which are subject to uniform corrosion:

- Steel in aerated water
- Stainless steel in reducing acids (such as EN 1.4301 (AISI 304) in sulfuric acid)

Pitting corrosion

Pitting corrosion is a localised form of corrosive attacks. Pitting corrosion forms holes or pits on the metal surface. It perforates the metal while the total corrosion, measured by weight loss, might be rather minimal. The rate of penetration may be 10 to 100 times that of general corrosion depending on the aggressiveness of the liquid. Pitting occurs more easily in a stagnant environment.

Example of metal that is subject to pitting corrosion:

- Stainless steel in seawater

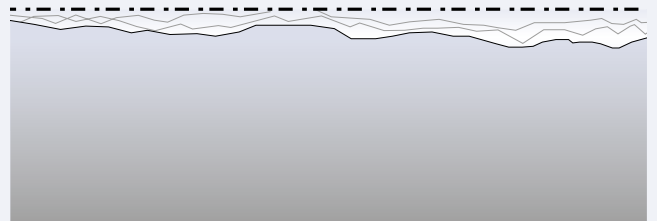


Fig. 1.6.3: Uniform corrosion

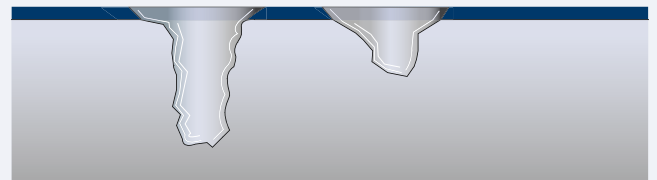


Fig. 1.6.4: Pitting corrosion

Section 1.6

Materials

Crevice corrosion

Crevice corrosion - like pitting corrosion - is a localised form of corrosion attack. However, crevice corrosion starts more easily than pitting. Crevice corrosion occurs at narrow openings or spaces between two metal surfaces or between metals and non-metal surfaces and is usually associated with a stagnate condition in the crevice. Crevices, such as those found at flange joints or at threaded connections, are thus often the most critical spots for corrosion.

Example of metal that is subject to crevice corrosion:

- Stainless steel in seawater

Intergranular corrosion

As the name implies, intergranular corrosion occurs at grain boundaries. Intergranular corrosion is also called intercrystalline corrosion. Typically, this type of corrosion occurs when chromium carbide precipitates at the grain boundaries during the welding process or in connection with insufficient heat treatment. A narrow region around the grain boundary may therefore deplete in chromium and become less corrosion resistant than the rest of the material. This is unfortunate because chromium plays an important role in corrosion resistance.

Examples of metals that are subject to intergranular corrosion:

- Stainless steel - which is insufficiently welded or heat-treated
- Stainless steel EN 1.4401 (AISI 316) in concentrated nitric acid

Selective corrosion

Selective corrosion is a type of corrosion which attacks one single element of an alloy and dissolves the element in the alloy structure. Consequently, the alloy's structure is weakened.

Examples of selective corrosion:

- The dezincification of unstabilised brass, whereby a weakened, porous copper structure is produced
- Graphitisation of gray cast iron, whereby a brittle graphite skeleton is left because of the dissolution of iron

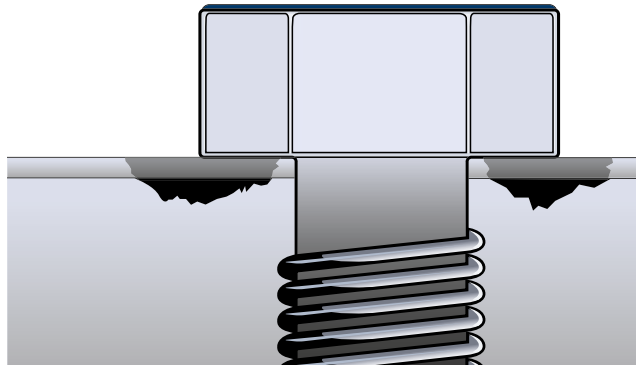


Fig. 1.6.5: Crevice corrosion

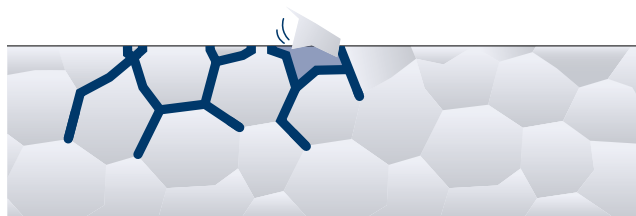


Fig. 1.6.6: Intergranular corrosion

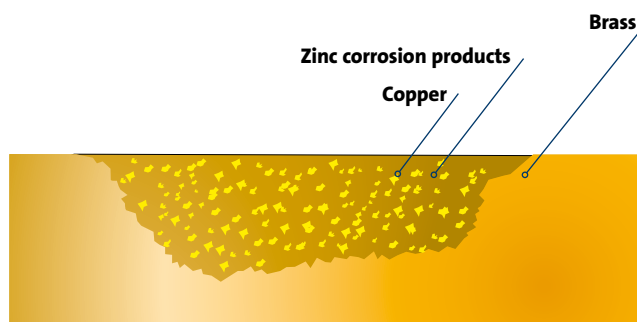


Fig. 1.6.7: Selective corrosion



Erosion corrosion

Erosion corrosion is a process that involves corrosion and erosion. The rate of corrosion attack is accelerated by the relative motion of a corrosive liquid and a metal surface. The attack is localised in areas with high velocity or turbulent flow. Erosion corrosion attacks are characterised by grooves with directional pattern.

Examples of metals which are subject to erosion corrosion:

- Bronze in seawater
- Copper in water

Cavitation corrosion

A pumped liquid with high velocity reduces the pressure. When the pressure drops below the liquid vapour pressure, vapour bubbles form (the liquid boils). In the areas where the vapour bubbles form, the liquid is boiling. When the pressure raises again, the vapour bubbles collapse and produce intensive shockwaves. Consequently, the collapse of the vapour bubbles remove metal or oxide from the surface.

Examples of metals that are subject to cavitation:

- Cast iron in water at high temperature
- Bronze in seawater

Stress corrosion cracking (SCC)

Stress corrosion cracking (SCC) refers to the combined influence of tensile stress (applied or internal) and corrosive environment. The material can crack without any significant deformation or obvious deterioration of the material. Often, pitting corrosion is associated with the stress corrosion cracking phenomena.

Examples of metals that are subject to stress corrosion cracking:

- Stainless steel EN 1.4401 (AISI 316) in chlorides
- Brass in ammonia

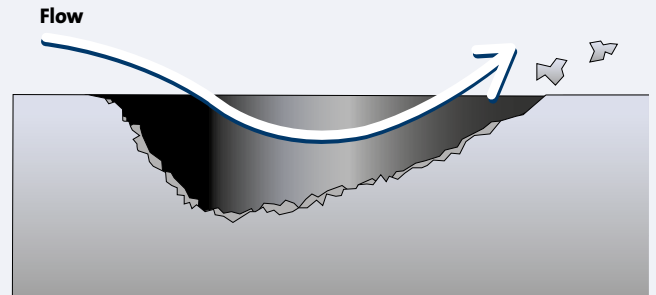


Fig. 1.6.8: Erosion corrosion

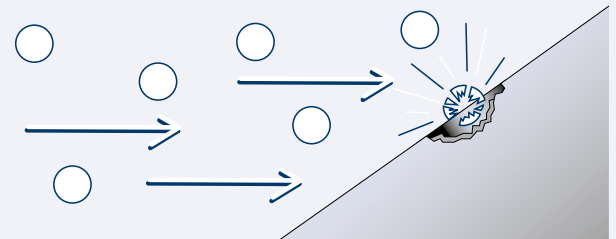


Fig. 1.6.9: Cavitation corrosion



Fig. 1.6.10: Stress corrosion cracking

Section 1.6

Materials

Corrosion fatigue

Pure mechanical fatigue is when a material subjected to a cyclic load far below the ultimate tensile strength can fail. If the metal is simultaneously exposed to a corrosive environment, the failure can take place at an even lower stress and after a shorter time. Contrary to a pure mechanical fatigue, there is no fatigue limit in corrosion-assisted fatigue.

Example of metals that are subject to corrosion fatigue:

- Aluminium structures in corrosive atmosphere

Galvanic corrosion

When a corrosive electrolyte and two metallic materials are in contact (galvanic cell), corrosion increases on the least noble material (the anode) and decreases on the noblest (the cathode). The increase in corrosion is called galvanic corrosion. The tendency of a metal or an alloy to corrode in a galvanic cell is determined by its position in the galvanic series. The galvanic series indicates the relative nobility of different metals and alloys in a given environment (e.g. seawater, see figure 1.6.12).

The farther apart the metals are in the galvanic series, the greater the galvanic corrosion effect will be. Metals or alloys at the upper end are noble, while those at the lower end are least noble.

Examples of metal that are subject to galvanic corrosion:

- Steel in contact with 1.4401
- Aluminium in contact with copper

The principles of galvanic corrosion are used in cathodic protection. Cathodic protection is a means of reducing or preventing the corrosion of a metal surface by the use of sacrificial anodes (zinc or aluminum) or impressed currents.

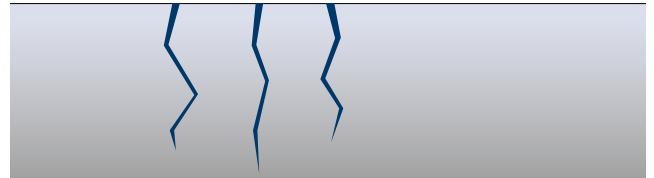


Fig. 1.6.11: Corrosion fatigue

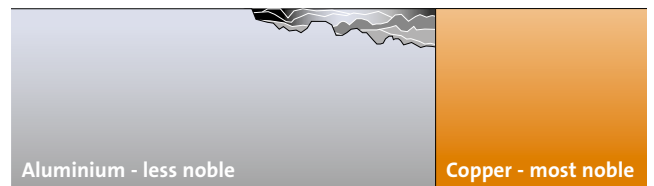


Fig. 1.6.12: Galvanic corrosion

Galvanic series for metals and alloys in seawater	
Noble, cathodic end (less likely to corrode)	
Platinum	
Gold	
Titanium (passive)	
Silver	
Stainless steel (passive)	
Copper	
Bronze	
Brass	
Tin	
Stainless steel (active)	
Steel	
Aluminium	
Zinc	
Magnesium	
Least noble, anodic end (most likely to corrode)	

Fig. 1.6.13: Galvanic series for metals and alloys in seawater



1.6.3 Metal and metal alloys

On the following pages, you can read about the features of different metals and metal alloys, used for construction of pumps.

Ferrous alloys

Ferrous alloys are alloys where iron is the prime constituent. Ferrous alloys are the most common of all materials because of their availability, low cost, and versatility.

Steel is a widely used material primarily composed of iron alloyed with carbon. The amount of carbon in steel varies in the range from 0.003% to 1.5% by weight. The content of carbon has an important impact on the material's strength, weldability, machinability, ductility, and hardness. As a rule-of-thumb, an increase in carbon content will lead to an increase in strength and hardness but to a decrease in ductility and weldability. The most common type of steel is carbon steel. Carbon steel is grouped into four categories, see figure 1.6.14.

Type of steel	Content of carbon
Low carbon or mild steel	0.003% to 0.30% of carbon
Medium carbon steel	0.30% to 0.45% of carbon
High carbon steel	0.45% to 0.75% of carbon
Very high carbon steel	0.75% to 1.50% of carbon

Fig 1.6.14: Four types of carbon steel

Steel is available in wrought as well as in cast condition. The general characteristics of steel castings are closely comparable to those of wrought steels. The most obvious advantage of steel is that it is relatively inexpensive to make, form and process. On the other hand, the disadvantage of steel is that its corrosion resistance is low compared to alternative materials, such as stainless steel.



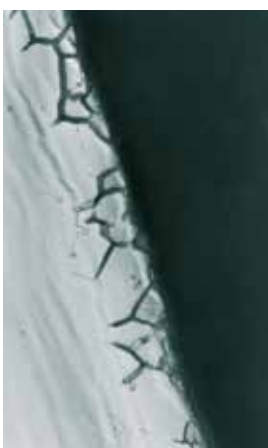
Cavitation corrosion of bronze impeller



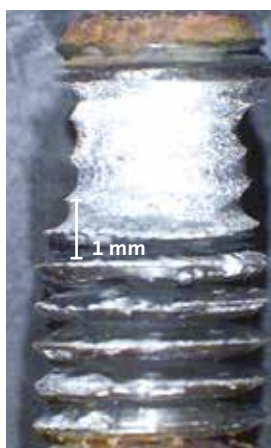
Erosion corrosion of cast iron impeller



Pitting corrosion of EN 1.4401 (AISI 316)



Intergranular corrosion of stainless steel



Crevice corrosion of EN 1.4462 (SAF 2205)

Section 1.6

Materials

Cast iron

Cast iron can be considered an alloy of iron, silicon and carbon. Typically, the concentration of carbon is between 3-4% by weight, most of which is present in insoluble form (e.g. graphite flakes or nodules). The two main types are grey cast iron and nodular (ductile) cast iron. The corrosion resistance of cast iron is comparable to the one for steel; and sometimes even better. Cast iron can be alloyed with 13-16% by weight silicon or 15-35% by weight nickel (Ni-resist) respectively in order to improve corrosion resistance. Various types of cast irons are widely used in industry, especially for valves, pumps, pipes and automotive parts. Cast iron has good corrosion resistance to neutral and alkaline liquids (high pH). But its resistance to acids (low pH) is poor.

Grey iron

Designations of grey iron			
Tensile strength N/mm ² , min.	EN 1563	DIN 1693	ISO 185
150	EN-GJL-150	GG-15	50
200	EN-GJL-200	GG-20	200
250	EN-GJL-250	GG-25	250

Fig 1.6.15: Comparison and designations of grey iron

In grey iron, the graphite is dispersed throughout a ferrite or pearlite matrix in the form of flakes. Fracture surfaces take on a grey appearance (hence the name!). The graphite flakes act as stress concentrators under tensile loads, making it weak and brittle in tension, but strong and ductile in compression. Grey iron is used for the construction of motor blocks because of its high vibration damping ability. Grey iron is an inexpensive material and is relatively easy to cast with a minimal risk of shrinkage. That is why grey iron is often used for pump parts with moderate strength requirements.

Nodular (ductile) iron

Designations of nodular iron			
Tensile strength N/mm ² , min.	EN 1563	DIN 1693	ISO 1083
400	EN-GJS-400-18	GGG-40	400-18
400	EN-GJS-400-15	GGG-40.3	400-15
450	EN-GJS-450-10	—	450-10
500	EN-GJS-500-7	GGG-50	500-7

Fig 1.6.16: Comparison and designations of nodular iron

Nodular iron contains around 0.03-0.05% by weight of magnesium. Magnesium causes the flakes to become globular so the graphite is dispersed throughout a ferrite or pearlite matrix in the form of spheres or nodules. The graphite nodules have no sharp features. The round shape of nodular graphite reduces the stress concentration and consequently, the material is much more ductile than grey iron. Figure 1.6.16 clearly shows that the tensile strength is higher for nodular iron than is the case for grey iron. Nodular iron is normally used for pump parts with high strength requirements (high pressure or high temperature applications).

Stainless steel

Stainless steel is chromium containing steel alloys. The minimum chromium content in standardised stainless steel is 10.5%. Chromium improves the corrosion resistance of stainless steel. The higher corrosion resistance is due to a chromium oxide film that is formed on the metal surface. This extremely thin layer is self-repairing under the right conditions. Molybdenum, nickel and nitrogen are other examples of typical alloying elements. Alloying with these elements brings out different crystal structures, which enable different properties in connection with machining, forming, welding, corrosion resistance, etc. In general, stainless steel has a higher resistance to chemicals (i.e. acids) than steel and cast iron have.



In environments containing chlorides, stainless steel can be attacked by localised corrosion, e.g. pitting corrosion and crevice corrosion. The resistance of stainless steel to these types of corrosion is highly dependent on its chemical composition. It has become rather common to use the so-called PRE (Pitting Resistance Equivalent) values as a measure of pitting resistance for stainless steel. PRE values are calculated by formulas in which the relative influence of a few alloying elements (chromium,

molybdenum and nitrogen) on the pitting resistance is taken into consideration. The higher the PRE, the higher the resistance to localised corrosion. Be aware that the PRE value is a very rough estimate of the pitting resistance of a stainless steel and should only be used for comparison/classification of different types of stainless steel. In the following, we will present the four major types of stainless steel: ferritic, martensitic, austenitic and duplex.

Fig 1.6.17: Chemical composition of stainless steel

Chemical composition of stainless steel [w%]							
Microstructure	Designation EN/AISI/UNS	% Carbon max.	% Chromium	% Nickel	% Molybdenum	% Other	PRE ⁵⁾
Ferritic	1.4016/430/ S43000	0.08	16-18				17
Martensitic	1.4057/431/ S43100	0.12-0.22	15-17	1.5-2.5			16
Austenitic	1.4305/303/ S30300	0.1	17-19	8-10		S 0.15-0.35	18
Austenitic	1.4301/304/ S30400	0.07	17-19.5	8-10.5			18
Austenitic	1.4306/304L/ S30403	0.03	18-20	10-12			18
Austenitic	1.4401/316/ S31600	0.07	16.5-18.5	10-13	2-2.5		24
Austenitic	1.4404/316L/ S31603	0.03	16.5-18.5	10-13	2-2.5		24
Austenitic	1.4571/316Ti/ S31635	0.08	16.5-18.5	10.5-13.5	2-2.5	Ti > 5 x carbon Ti < 0.70	24
Austenitic	1.4539/904L/ N08904	0.02	19-21	24-26	4-5	Cu 1.2-2	34
Austenitic	1.4547/none / S 31254 ³⁾	0.02	20	18	6.1	N 0.18-0.22 Cu 0.5-1	43
Ferritic/ austenitic	1.4462/ none/ S32205 ²⁾	0.03	21-23	4.5-6.5	2.5-3.5	N 0.10-0.22	34
Ferritic/ austenitic	1.4410/none/ S 32750 ⁴⁾	0.03	25	7	4	N 0.24-0.32	43
Microstructure	Designation EN/ASTM/UNS	% Carbon max.	% Chromium	% Nickel	% Molybdenum	% Other	PRE
Austenitic ¹⁾	1.4308/CF8/ J92600	0.07	18-20	8-11			19
Austenitic ¹⁾	1.4408/CF8M/ J92900	0.07	18-20	9-12	2-2.5		26
Austenitic ¹⁾	1.4409/CF3M/ J92800	0.03	18-20	9-12	2-2.5	N max. 0.2	26
Austenitic	1.4584/none/ none	0.025	19-21	24-26	4-5	N max. 0.2 Cu 1-3	35
Ferritic/ austenitic	1.4470/CD3MN/ J92205	0.03	21-23	4.5-6.5	2.5-3.5	N 0.12-0.2	35
Ferritic/ austenitic	1.4517/CD4MCuN/ J93372	0.03	24.5-26.5	2.5-3.5	2.5-3.5	N 0.12-0.22 Cu 2.75-3.5	38

1) Contains some ferrite 2) Also known as SAF 2205, 3) Also known as 254 SMO, 4) Also known as SAF 2507
5) Pitting Resistance Equivalent (PRE): Cr% + 3.3xMo% + 16xN%.

Section 1.6

Materials

Ferritic (magnetic)

Ferritic stainless steel is characterised by quite good corrosion properties, very good resistance to stress corrosion cracking and moderate toughness. Low alloyed ferritic stainless steel is used in mild environments (teaspoons, kitchen sinks, washing machine drums, etc) where it is a requirement that the component is maintenance-free and non-rusting.

Martensitic (magnetic)

Martensitic stainless steel is characterised by high strength and limited corrosion resistance. Martensitic steels are used for springs, shafts, surgical instruments and for sharp-edged tools, such as knives and scissors.

Austenitic (non-magnetic)

Austenitic stainless steel is the most common type of stainless steel and is characterised by a high corrosion resistance, very good formability, toughness and weldability. Austenitic stainless steel, especially the EN 1.4301 and EN 1.4401 are used for almost any type of pump components in the industry. This kind of stainless steel can be either wrought or cast.

EN 1.4305 is one of the most popular stainless steel types of all the free machining stainless steel types. Due to its high sulphur content (0.15-0.35 w%), the machinability has improved considerably but unfortunately at the expense of its corrosion resistance and its weldability. However, over the years free machining grades with a low sulphur content and thus a higher corrosion resistance have been developed.

If stainless steel is heated up to 500°C - 800°C for a longer period of time during welding, the chromium might form chromium carbides with the carbon present in the steel. This reduces chromium's capability to maintain the passive film and might lead to intergranular corrosion also referred to as sensitisation (see section 1.6.2). If low carbon grades of stainless steel are used the risk of sensitisation is reduced. Stainless steel with a low content

of carbon is referred to as EN 1.4306 (AISI 304L) or EN 1.4404 (AISI 316L). Both grades contain 0.03% of carbon compared to 0.07% in the regular type of stainless steel EN 1.4301 (AISI 304) and EN 1.4401 (AISI 316), see illustration 1.6.17.

The stabilised grades EN 1.4571 (AISI 316Ti) contain a small amount of titanium. Because titanium has a higher affinity for carbon than chromium, the formation of chromium carbides is minimised. The content of carbon is generally low in modern stainless steel, and with the easy availability of 'L' grades the use of stabilised grades has declined markedly.

Ferritic-austenitic or duplex (magnetic)

Ferritic-austenitic (duplex) stainless steel is characterised by high strength, good toughness, high corrosion resistance and excellent resistance to stress corrosion cracking and corrosion fatigue in particular.

Ferritic-austenitic stainless steel is typically used in applications that require high strength, high corrosion resistance and low susceptibility to stress corrosion cracking or a combination of these properties. Stainless steel EN 1.4462 is widely used for making pump shafts and pump housings.



Nickel alloys

Nickel base alloys are defined as alloys in which nickel is present in greater proportion than any other alloying element. The most important alloying constituents are iron, chromium, copper, and molybdenum. The alloying constituents make it possible to form a wide range of alloy classes. Nickel and nickel alloys have the ability to withstand a wide variety of severe operating conditions, for instance corrosive environments, high temperatures, high stresses or a combination of these factors.

Hastelloys™ alloys are a line of commercial alloys containing Ni, Mo, Cr, and Fe. Nickel base alloys, such as Inconel™ Alloy 625, Hastelloys™ C-276 and C-22 are highly corrosion resistant and not subject to pitting or crevice corrosion in low velocity seawater and do not suffer from erosion at high velocity.

The price of nickel base alloy limits its use in certain applications. Nickel alloys are available in both wrought and cast grades. However, nickel alloys are more difficult to cast than the common carbon steels and stainless steel alloys. Nickel alloys are especially used for pump parts in the chemical process industry.

Copper alloys

Pure copper has excellent thermal and electrical properties, but is a very soft and ductile material. Alloying additions result in different cast and wrought materials, which are suitable for use in the production of pumps, pipelines, fittings, pressure vessels and for many marine, electrical and general engineering applications.

Common types of copper alloys				
Material	Main alloying elements [w%] ¹⁾			
	Zinc	Tin	Nickel	Cu
Brass	10-30	-	-	rest
Red brass (gunmetal)	5-10	5-10	-	rest
Bronze ²⁾	-	10	-	rest
Cupro nickel	-	-	20-30	rest

1) Lead can be added as an alloying element to improve machinability.

2) Bronze can be alloyed with aluminium to increase strength.

Fig 1.6.18: Common types of copper alloys

Brasses are the most widely used of the copper alloys because of their low cost, their easy or inexpensive fabrication and machining. However, they are inferior in strength to bronzes and must not be used in environments that cause dezincification (see section on selective corrosion).

Red brass, bronze and copper nickels in particular have, compared to cast iron a high resistance to chlorides in aggressive liquids, such as seawater. In such environments, brass is unsuitable because of its tendency to dezincificate. All copper alloys have poor resistance to alkaline liquids (high pH), ammonia and sulfides and are sensitive to erosion. Brass, red brass and bronze are widely used for making bearings, impellers and pump housings.

Aluminium

Designation	Major alloying element
1000-series	Unalloyed (pure) >99% Al
2000-series	Copper is the principal alloying element, though other elements (magnesium) may be specified
3000-series	Manganese is the principal alloying element
4000-series	Silicon is the principal alloying element
5000-series	Magnesium is the principal alloying element
6000-series	Magnesium and silicon are principal alloying elements
7000-series	Zinc is the principal alloying element, but other elements, such as copper, magnesium, chromium, and zirconium may be specified
8000-series	Other elements (including tin and some lithium compositions)

Fig 1.6.19: Major alloying elements of aluminium

Pure aluminium is a light and soft metal with a density of about a third of that of steel. Pure aluminium has a high electrical and thermal conductivity. The most common alloying elements are silicon (silumin), magnesium, iron and copper. Silicon increases the material's castability, copper increases its machinability and magnesium increases its corrosion resistance and strength.

The obvious advantages of aluminium are that the material naturally generates a protective oxide film and is highly corrosion resistant if it is exposed to the atmosphere. Treatment, such as anodising, can further improve this property. Aluminium alloys are widely used in structures where a high strength to weight ratio is important, such as in the transportation industry. For example, the use of aluminium in vehicles and aircrafts reduces weight and energy consumption.

On the other hand, the disadvantage of aluminium is that it is not stable at low or high pH and in chloride-containing environments. This property makes aluminium unsuitable for exposure to aqueous solutions especially under conditions with high flow. This is further emphasised by the fact that aluminium is a reactive metal, i.e. has a low position in the galvanic series (see section on galvanic corrosion) and may easily suffer from galvanic corrosion if coupled to nobler metals and alloys.

Titanium

Titanium grades ASTM	Alloy characteristics	Attributes
Grade 1, 2, 3, 4	CP grades with increasing oxygen content	Corrosion resistance with ease of fabrication and welding
Grade 7, 11	CP grades with palladium addition	Enhanced corrosion resistance to reducing acids and crevice corrosion
Grade 5	6% Al, 4% V	'Workhorse' alloy with high strength. Widely used in the aircraft industry

CP: commercial pure (titanium content above 99.5%)

Fig 1.6.20: Titanium grades and alloy characteristics

Pure titanium has a low density, is quite ductile and has a relatively low strength. However, when a limited amount of oxygen is added it will strengthen titanium and produce the so-called commercial-pure grades. Additions of various alloying elements, such as aluminium and vanadium increase its strength significantly, at the expense of ductility. The aluminium and vanadium - alloyed titanium (Ti-6Al-4V) is the "workhorse" alloy of the titanium industry. It is used in many aerospace engine and airframe components. Because titanium is a high-price material, it is not yet a material which is often used for making pump components.

Titanium is a very reactive material. As it is the case for stainless steel, titanium's corrosion resistance depends on the formation of an oxide film. However, the oxide film is more protective than that on stainless steel. Therefore, titanium performs much better than stainless steel in aggressive liquids, such as seawater, wet chlorine or organic chlorides, that cause pitting and crevice corrosion.



1.6.4 Ceramics

Ceramic materials are defined as inorganic, non-metallic materials, which are typically crystalline in nature. They are composed of metallic and non-metallic elements. Common technical ceramics are aluminium oxide (alumina - Al_2O_3), silicon carbide (SiC), tungsten carbide (WC), and silicon nitride (Si_3N_4).

Ceramics are suitable for applications which require high thermal stability, high strength, high wear resistance, and high corrosion resistance. The disadvantage of ceramics is the low ductility and high tendency for brittle fractures. Ceramics are mainly used for making bearings and seal faces for shaft seals.

1.6.5 Plastics

Abbreviation	Polymer name
PP	Polypropylene
PE	Polyethylene
PVC	Polyvinylchloride
PEEK	Polyetheretherketone
PVDF	Polyvinylidene fluoride
PTFE*	Polytetrafluoroethylene

*Trade name: Teflon®

Fig 1.6.21: Overview of polymer names

Some plastics are derived from natural substances, such as plants, but most types are man-made. These are known as synthetic plastics. Most synthetic plastics come from crude oil, but coal and natural gas are also used. There are two main types of plastics: Thermoplastics and thermosets (thermosetting plastics). The thermoplastics are the most common kind of plastic used worldwide. Plastics often contain additives, which transfer certain additional properties to the material. Furthermore, plastics can be reinforced with fibreglass or other fibres. These plastics together with additives and fibres are also referred to as composites.

Examples of additives found in plastics

- Inorganic fillers for mechanical reinforcement
- Chemical stabilisers, e.g. antioxidants
- Plasticisers
- Flame retardants

Thermoplastics

Thermoplastic polymers consist of long polymer molecules that are not linked to each other, i.e. have no cross-links. They are often supplied as granules and heated to permit fabrication by methods, such as moulding or extrusion.

A wide range is available, from low-cost commodity plastics (e.g. PE, PP, PVC) to high cost engineering thermoplastics (e.g. PEEK) and chemical resistant fluoropolymers (e.g. PTFE, PVDF). PTFE is one of the few thermoplastics, which is not melt-processable. Thermoplastics are widely used for making pump housings or for lining of pipes and pump housings.

Thermosets

Thermosets harden permanently when heated, as cross-linking hinders bending and rotations. Cross-linking is achieved during fabrication using chemicals, heat, or radiation; this process is called curing or vulcanization. Thermosets are harder, more dimensionally stable, and more brittle than thermoplastics and cannot be remelted. Important thermosets include epoxies, polyesters, and polyurethanes. Thermosets are among other things used for surface coatings.

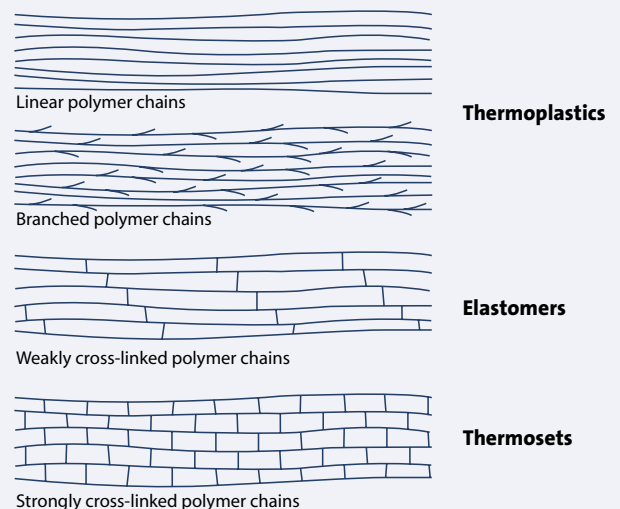


Fig 1.6.22: Different types of polymers

1.6.6 Rubber

Abbreviation	Common name	Examples of trade name
NBR	Nitrile rubber	Buna-N [®]
EPDM, EPM	Ethylene propylene rubber	Nordel [®]
FKM	Fluoroelastomers	Viton [®]
MQ, VMQ, PMQ, FMQ	Silicone rubber	Siloprene [®]
FFKM	Perfluoroelastomers	Chemraz [®] Kalrez [®]

Fig 1.6.23: Rubber types

The term rubber includes both natural rubber and synthetic rubber. Rubbers (or elastomers) are flexible long-chain polymers that can be stretched easily to several times their unstretched length and which rapidly return to their original dimensions when the applied stress is released. Rubbers are cross-linked (vulcanized), but have a low cross-link density, see figure 1.6.22. The cross-link is the key to the elastic, or rubbery, properties of these materials. The elasticity provides resiliency in sealing applications. Different components in a pump are made of rubber, e.g. gaskets and O-rings (see section 1.3 on shaft seals). In this section we will present the different kinds of rubber qualities and their main properties as regards temperature and resistance to different kinds of liquid groups.

Nitrile rubber (NBR)

At temperatures up to about 100°C nitrile rubber is an inexpensive material that has a high resistance to oil and fuel. Different grades exist - the higher the acrylonitrile (ACN) content, the higher the oil resistance, but the poorer is the low temperature flexibility. Nitrile rubbers have high resiliency and high wear resistance but only moderate strength. Further, the rubber has limited weathering resistance and poor solvent resistance. It can generally be used down to about -30°C, but certain grades can operate at lower temperatures.

Ethylene propylene rubber (EPDM)

Ethylene propylene has excellent water resistance which is maintained to high temperatures approximately 120-140°C. The rubber type has good resistance to acids, strong alkalis and highly polar fluids, such as methanol and acetone. However, it has very poor resistance to mineral oil and fuel.

Fluoroelastomers (FKM)

Fluoroelastomers cover a whole family of rubbers designed to withstand oil, fuel and a wide range of chemicals including non-polar solvents. FKM offers excellent resistance to high temperature operation (up to 200°C depending on the grade) in air and different types of oil. FKM rubbers have limited resistance to steam, hot water, methanol, and other highly polar fluids. Further, this type of rubber has poor resistance to amines, strong alkalis and many freons. There are standard and special grades - the latter have special properties, such as improved low-temperature or chemical resistance.

Silicone rubber (Q)

Silicone rubbers have outstanding properties, such as low compression set in a wide range of temperatures (from -60°C to 200°C in air), excellent electrical insulation and are non-toxic. Silicone rubbers are resistant to water, some acids and oxidizing chemicals. Concentrated acids, alkalines, and solvents should not be used with silicone rubbers. In general, these types of rubber have poor resistance to oil and fuel. However, the resistance of FMQ silicone rubber to oil and fuel is better than that of the silicone rubber types MQ, VMQ, and PMQ.

Perfluoroelastomers (FFKM)

Perfluoroelastomers have very high chemical resistance, almost comparable to that of PTFE (polytetrafluorethylene, e.g. Teflon[®]). They can be used up to high temperatures, but their disadvantages are difficult processing, very high cost and limited use at low temperatures.



1.6.7 Coatings

Protective coating – metallic, non-metallic (inorganic) or organic – is a common method of corrosion control. The main function of coatings is (aside from galvanic coatings, such as zinc) to provide an effective barrier between the metal (substrate) and its environment. They allow the use of normal steel or aluminium instead of more expensive materials. In the following section we will examine the possibilities of preventing corrosion by means of different coatings:

Metallic and non-metallic (inorganic) coatings and organic coatings.

Metallic coatings

Metallic coatings less noble than the substrate

Zinc coatings are commonly used for the protection of steel structures against atmospheric corrosion. Zinc has two functions: it acts as a barrier coating and it provides galvanic protection. Should an exposed area of steel occur, the zinc surface preferentially corrodes at a slow rate and protects the steel. The preferential protection is referred to as cathodic protection. When damage is small, the protective corrosion products of zinc will fill the exposed area and stop the attack.

Metallic coatings nobler than the substrate

Electroplating of nickel and chromium coatings on steel are examples of metallic coatings that are nobler than the substrate. Unlike galvanic coatings where the coating corrodes near areas where the base metal is exposed, any void or damage in a barrier coating can lead to an immediate base metal attack.

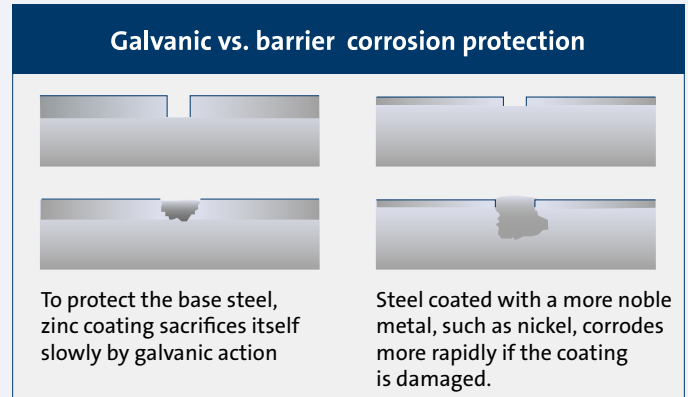


Fig 1.6.24: Galvanic vs. barrier corrosion protection

Non-metallic coatings (inorganic coatings)

Conversion coatings are an important category of non-metallic coatings (inorganic).

Conversion coatings

Conversion coatings are formed by a controlled corrosion reaction of the substrate in an oxidised solution. Well-known examples of conversion coatings are anodising or chromating of aluminium, and phosphate treatment of steel. Anodising is mainly used for surface protection of aluminium, while chromating and phosphating are usually used for pre-treatment in connection with painting. Besides improving paint adhesion, it helps to prevent the spreading of rust under layers of paint.

Organic coatings

Organic coatings contain organic compounds and are available in a wide range of different types. Organic coatings are applied to the metal by methods of spraying, dipping, brushing, lining or electro-coating (paint applied by means of electric current) and they may or may not require heat-curing. Both thermoplastic coatings, such as polyamide, polypropylene, polyethylene, PVDF and PTFE and elastomer coatings are applied to metal substrates to combine the mechanical properties of metal with the chemical resistance of plastics but paints are by far the most widely used organic coating.

Paints

As mentioned above, paints are an important class of organic coating. Figure 1.6.25 shows several types of organic coatings. A typical paint formulation contains polymeric binders, solvents, pigments and additives. For environmental reasons, organic solvents are increasingly being replaced by water or simply eliminated, e.g powder coating. Painted metal structures usually involve two or more layers of coating applied on a primary coating, which is in direct contact with the metal.

Physical states of common organic coatings				
Resin type	Solvent-based	Water-based	Powder coating	Two comp. liquid
Acrylic	X	X	X	
Alkyd	X	X		
Epoxy	X	X	X	X
Polyester	X		X	X
Polyurethane	X	X	X	X
Vinyl	X	X	X	

Fig 1.6.25: Physical states of common organic coatings

Chapter 2. Installation and performance reading

Section 2.1: Pump installation

- 2.1.1 New installation
- 2.1.2 Existing installation-replacement
- 2.1.3 Pipe flow for single-pump installation
- 2.1.4 Limitation of noise and vibrations
- 2.1.5 Sound level (L)

Section 2.2: Pump performance

- 2.2.1 Hydraulic terms
- 2.2.2 Electrical terms
- 2.2.3 Liquid properties



Section 2.1

Pump installation

Correct advice and selection of pump type for an installation has larger implication than what meets the eye. The larger the pumps, the greater the costs with respect to investment, installation, commissioning, running and maintenance – basically the life cycle costs (LCC). An extensive product portfolio combined with competent advice and after-sales service is the foundation of a correct selection. The following analysis, recommendations and hints are general for any installation, but to a greater extent relevant for medium-sized and large installations. We will present our recommendations for two types of installation: New and existing installations.

2.1.1 New installation

- If the pipework has not been planned yet, you can base the selection of pump type on other primary selection criteria, e.g. efficiency, investment costs or life cycle costs (LCC). This will not be covered in this section. However, the general guidelines, which are presented, also apply for pipework that has not yet been planned.
- If the pipework has already been planned, the selection of pump is equivalent to replacing a pump in an existing installation.

2.1.2 Existing installation – replacement

The following five steps will help you make an optimum pump selection for an existing installation:

Pre-investigation of the installation should include the following considerations:

- Basic pipe flow – pipes in and out of the building, e.g. from ground, along floor or from ceiling
- Specific pipework at the point of installation, e.g. in-line or end-suction, dimensions, manifolds
- Space available – width, depth and height
- Accessibility in connection with installation and maintenance, for instance doorways
- Availability of lifting equipment or alternatively accessibility of such equipment
- Floor type, e.g. solid or suspended floor with basement
- Existing foundation
- Existing electric installation

Previous pump installation

- Pump make, type, specifications including old duty point, shaft seal, materials, gaskets, controlling
- History, e.g. lifetime, maintenance

Future requirements

- Desired improvements and benefits
- New selection criteria including duty points and operating times, temperature, pressure, liquid specifications
- Supplier criteria, e.g. availability of spare parts

Advisory

- Major changes might be beneficial in a long or short term or both and must be documented, e.g. installation savings, life cycle costs (LCC), reduction on environmental impact like noise and vibrations and accessibility in connection with maintenance

Selection

- Must be based on a customer-agreed list of priorities

For the selection of the correct pump type and advice on installation, two main areas are important: Pipe flow and limitation of noise and vibrations. These two areas will be dealt with on the following pages.



2.1.3 Pipe flow for single-pump installation

Figure 2.1.1 is based on single-pump installation. In parallel installations accessibility plays a major role for how good a pump choice is.

The evaluation criterion is as simple pipework as possible, hence as few bends as possible.

Scores:

- ▲ **Best choice**
- ◀ **Good choice**
- ▼ **Least good choice**
- × **Not applicable**

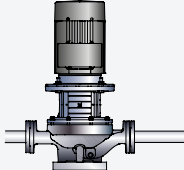
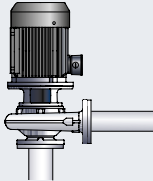
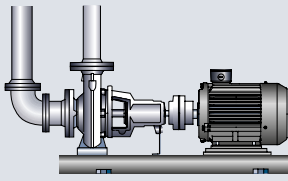













Pump type Pipework		Pump type		
				
To the pump:	From the pump:	A. In-line close-coupled (horizontal or vertical mounting)	B. End-suction close-coupled (horizontal or vertical mounting)	C. End-suction long-coupled (only horizontal mounting)
 Along floor	Along floor 	▲ Best choice	◀ Good choice	◀ Good choice
	To ground 	▲ Best choice	◀ Good choice	◀ Good choice
	To ceiling 	◀ Good choice	▲ Best choice	▲ Best choice
 From ground	Along floor 	◀ Good choice	▲ Best choice	▼ Least good choice
	To ground 	◀ Good choice	▲ Best choice	▼ Least good choice
	To ceiling 	◀ Good choice	▲ Best choice	▲ Best choice
 From ceiling	Along floor 	▲ Best choice	▼ Least good choice	▼ Least good choice
	To ground 	▲ Best choice	◀ Good choice	◀ Good choice
	To ceiling 	◀ Good choice	▲ Best choice	▲ Best choice
Wall-mounted	Wall-mounted 	▲ Best choice	◀ Good choice	× Not applicable

Fig. 2.1.1 Pipework and pump type

Section 2.1

Pump installation

Accessibility plays a major role in how well a specific pump choice is in connection with installation of several pumps in parallel. The accessibility is not always easy for in-line pumps installed in parallel because of the pipework, see figure 2.1.2. As it appears from figure 2.1.3, end-suction pumps installed in parallel provide easier accessibility.

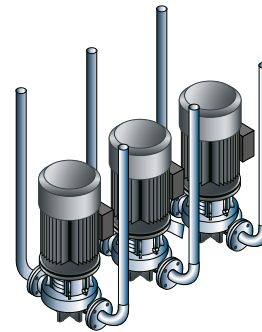


Fig. 2.1.2:
3 in-line pumps in parallel; limited maintenance access because of pipework

2.1.4 Limitation of noise and vibrations

To achieve optimum operation and minimise noise and vibration, it may be necessary to consider vibration dampening of the pump in certain cases. Generally, this should always be considered in the case of pumps with motors above 7.5 kW. Smaller motor sizes, however, may also cause undesirable noise and vibration. Noise and vibration are generated by the rotation in motor and pump and by the flow in pipes and fittings. The effect on the environment depends on correct installation and the state of the entire system. Below, we will present 3 different ways of limiting noise and vibration in a pump installation: Foundation, dampeners and expansion joint.

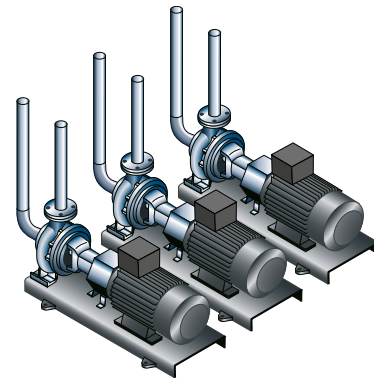


Fig. 2.1.3:
3 end-suction pumps in parallel; easier maintenance access because of pipework

Foundation

Floor constructions can be divided into two types: Solid floor and suspended floor.

Solid – minimum risk of noise due to bad transmission of vibrations, see figure 2.1.4.

Suspended – risk of floor amplifying the noise. Basement can act as a resonance box, see figure 2.1.5.

The pump should be installed on a plane and rigid surface. Four basic ways of installation exist for the two types of floor construction: Floor, plinth, floating plinth and foundation suspended on vibration dampeners.

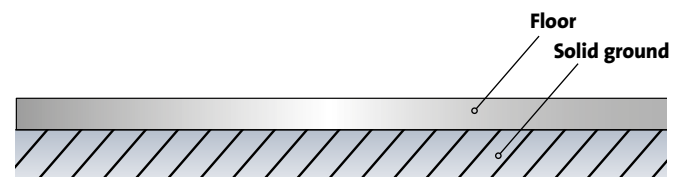


Fig. 2.1.4: Solid floor construction

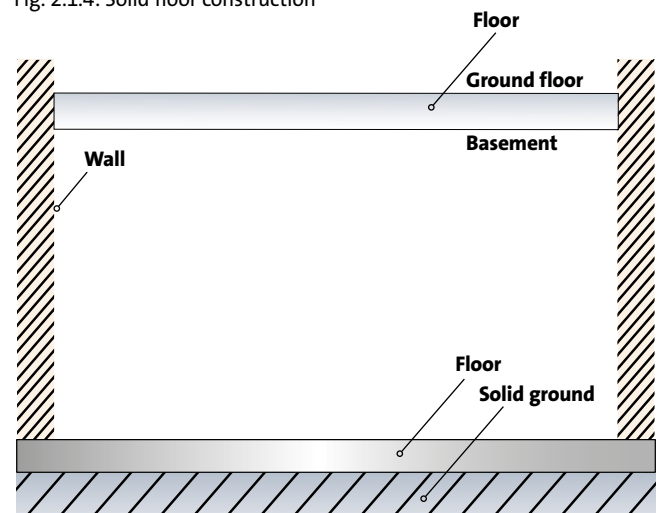


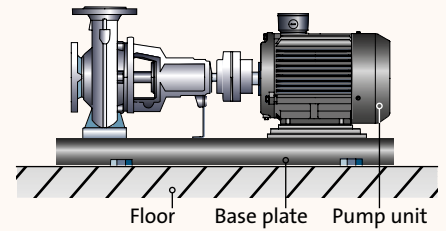
Fig. 2.1.5: Suspended floor construction



Floor

Direct mounting on floor, hence direct vibration transmission, see figure 2.1.6.

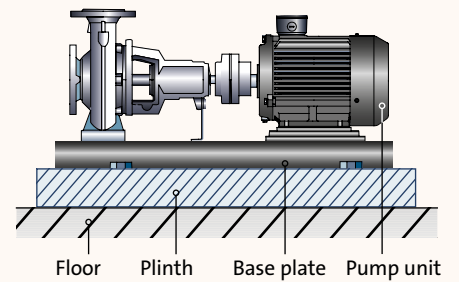
Fig. 2.1.6: Floor



Plinth

Poured directly on concrete floor, hence as floor, see figure 2.1.7.

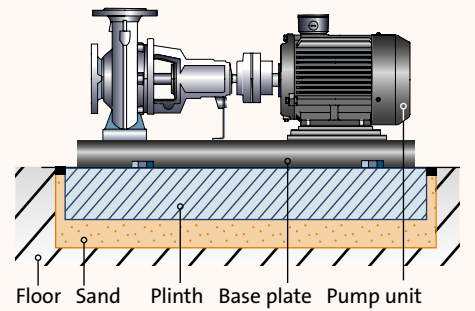
Fig. 2.1.7: Plinth



Floating plinth

Resting on a dead material, e.g. sand, hence reduced risk of vibration transmission, see figure 2.1.8.

Fig. 2.1.8: Floating plinth



Foundation suspended on vibration dampeners

Optimum solution with controlled vibration transmission, see figure 2.1.9.

As a rule of thumb, the weight of a concrete foundation should be 1.5 x the pump weight. This weight is needed to get the dampeners to work efficiently at low pump speed.

Fig. 2.1.9: Foundation suspended on vibration dampeners

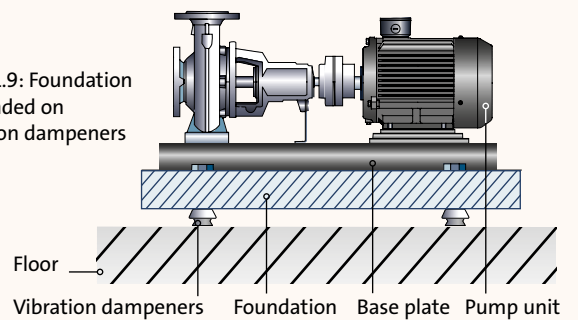
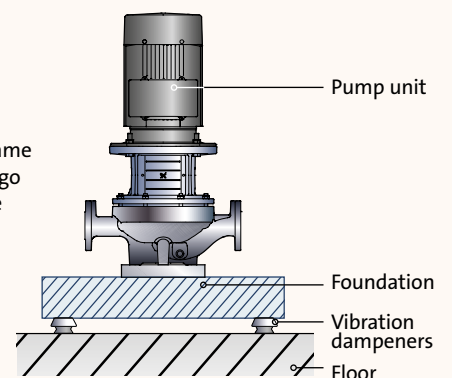


Fig. 2.1.10: The same foundation rules go for vertical in-line pumps



Section 2.1

Pump installation

Dampeners

The selection of the right vibration dampener requires the following data:

- Forces acting on the dampener
- Motor speed considering speed control, if any
- Required dampening in % (suggested value is 70%)

The determination of the right dampener varies from installation to installation but a wrong selection of dampener may increase the vibration level in certain cases. The supplier should therefore size vibration dampeners.

Pumps installed with vibration dampeners must always have expansion joints fitted at both the suction and the discharge side. This is important in order to avoid that the pump hangs in the flanges.

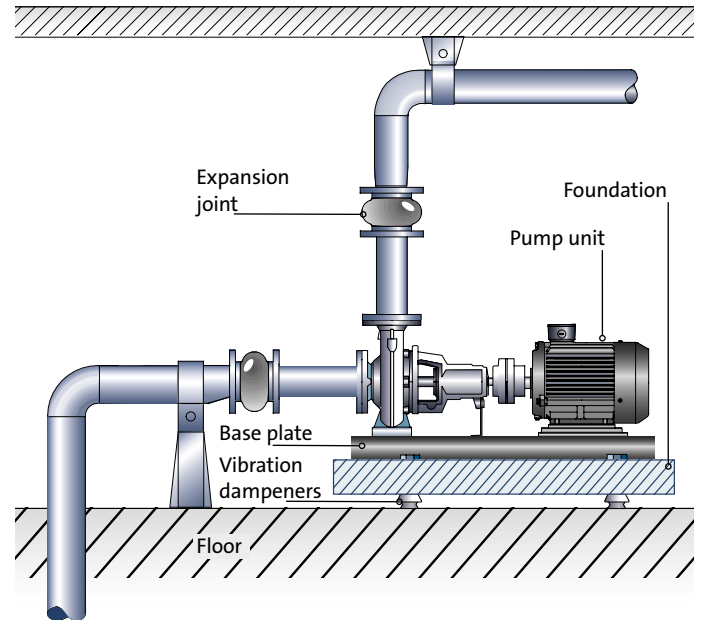


Fig. 2.1.11: Installation with expansion joints, vibration dampeners and fixed pipework

Expansion joints

Expansion joints are installed to:

- absorb expansions/contractions in the pipework caused by changing liquid temperature
- reduce mechanical strains in connection with pressure waves in the pipework
- isolate mechanical noise in the pipework (not for metal bellows expansion joints)

Expansion joints must not be installed to compensate for inaccuracies in the pipework, such as centre displacement or misalignment of flanges.

Expansion joints are fitted at a distance of minimum 1 to 1.5 · DN diameter from the pump on the suction side as well as on the discharge side. This prevents the development of turbulence in the expansion joints, resulting in better suction conditions and a minimum pressure loss on the pressure side. At high water velocities (>5 m/s) it is best to install larger expansion joints corresponding to the pipework.



Figures 2.1.12-2.1.14 show examples of rubber bellows expansion joints with or without tie bars.

Expansion joints with tie bars can be used to minimise the forces caused by the expansion joints. Expansion joints with tie bars are recommended for sizes larger than DN 100. An expansion joint without tie bars will exert force on the pump flanges. These forces affect the pump and the pipework.

The pipes must be fixed so that they do not stress the expansion joints and the pump, see figure 2.1.11. The fix points should always be placed as close to the expansion joints as possible. Follow the expansion joint supplier's instructions.

At temperatures above 100°C combined with a high pressure, metal bellows expansion joints are often preferred due to the risk of rupture.

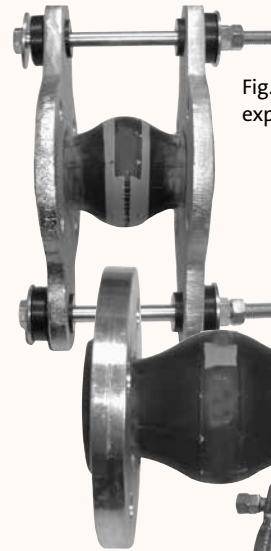


Fig. 2.1.12: Rubber bellows expansion joints with tie bars

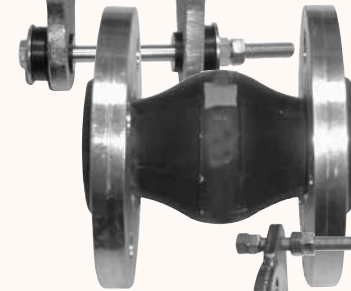


Fig. 2.1.13: Rubber bellows expansion joints without tie bars

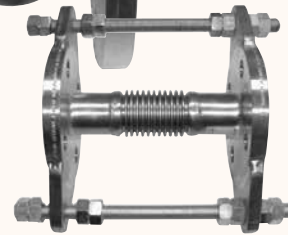


Fig. 2.1.14: Metal bellows expansion joints with tie bars

2.1.5 Sound level (L)

The sound level in a system is measured in decibel (dB). Noise is unwanted sound. The level of noise can be measured in the following three ways:

1. Pressure – L_p : The pressure of the air waves
2. Power – L_w : The power of the sound
3. Intensity - L_i : The power per m^2 (will not be covered in this book)

It is not possible to compare the three values directly, but it is possible to calculate between them based on standards. The rule-of-thumb is:

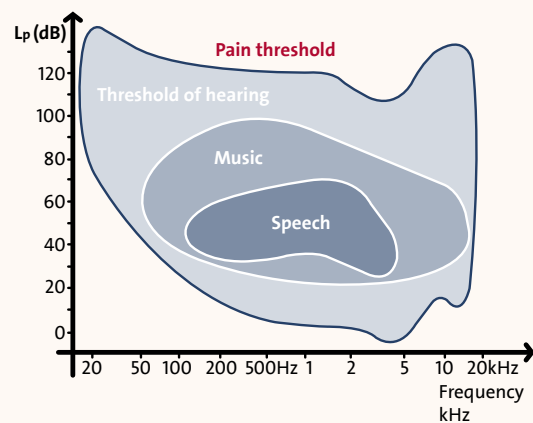


Fig. 2.1.15: Threshold of hearing vs. frequency

Smaller pumps, e.g. 1.5 kW: $L_w = L_p + 11$ dB

Larger pumps, e.g. 110 kW: $L_w = L_p + 16$ dB

Section 2.1

Pump installation

The EU Machine Directive prescribes that sound levels have to be indicated as pressure when they are below 85 dB(A) and as power when they exceed 85 dB(A).

Noise is subjective and depends on a person's ability to hear, e.g. young vs. old person. Therefore, the above-mentioned measurements get weight according to the sensibility of a standard ear, see figure 2.1.15. The weighting is known as A-weighting (dB(A)), expressed as e.g: L_{pA} , and the measurements are adjusted depending on frequency. In some cases it increases and in other cases it decreases, see figure 2.1.16. Other weightings are known as B and C but they are used for other purposes, which we do not cover in this book.

In case of two or more pumps in operation, the sound level can be calculated. If it is pumps with the same sound level the total sound level can be calculated adding the value from figure 2.1.17, e.g. 2 · pumps is $L_p + 3$ dB, 3 · pumps is $L_p + 5$ dB. If the pumps have different sound level, values from figure 2.1.18 can be added.

Indications of sound level should normally be stated as free field conditions over reflecting surface, meaning the sound level on a hard floor with no walls. Guaranteeing values in a specific room in a specific pipe system is difficult because these values are beyond the reach of the manufacturer. Certain conditions could have a negative impact (increasing sound level) or a positive impact on the sound level. Recommendations to installation and foundation can be given to eliminate or reduce the negative impact.

Experience values:

Rise of	Perceived as:
+ 3 dB	Just noticeable
+ 5 dB	Clearly noticeable
+10 dB	Twice as loud

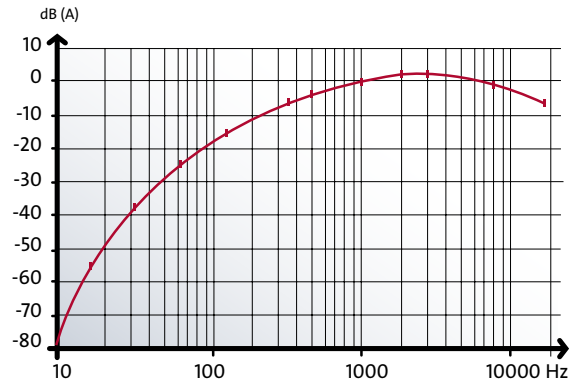


Fig. 2.1.16 A-weighting curve

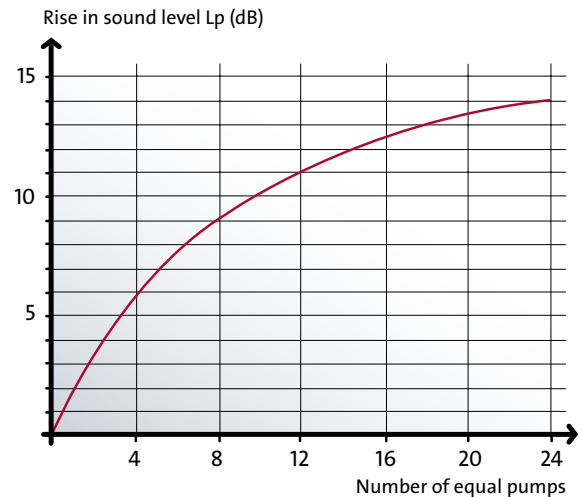


Fig. 2.1.17 Increase of the total sound pressure level with equal sources

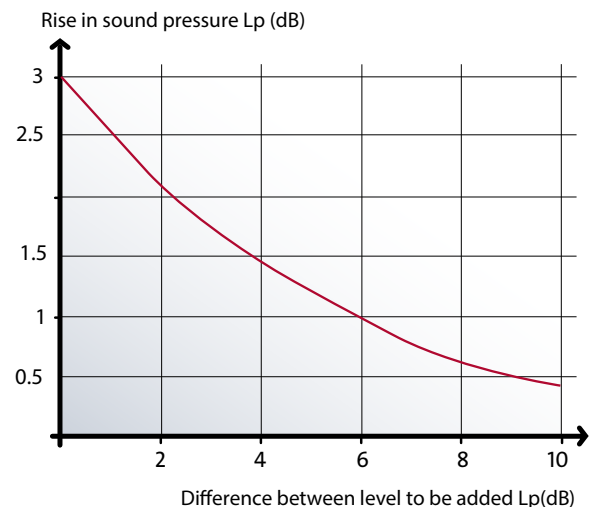


Fig. 2.1.18 Increase of the total sound pressure level with different sources

Section 2.2

Pump performance



When you examine a pump, there are several things you have to check. Besides checking the pump's physical condition, for instance if it is rusty or makes abnormal noise, you have to know a number of values in order to be able to tell if the pump performs as it is supposed to. On the next pages, we will present three groups of values you may need to focus on when you examine a pump's performance: Hydraulic terms, electrical terms, mechanical terms and liquid properties.

2.2.1 Hydraulic terms

When you want to examine pump performance, there are a number of values you need to know. In this section, we will present the most important hydraulic terms: Flow, pressure and head.

Flow

Flow is the amount of liquid that passes through a pump within a certain period of time. When we deal with performance reading, we distinguish between two flow parameters: Volume flow and mass flow.

Volume flow (Q)

Volume flow is what we can read from a pump curve or put in another way, a pump can move a volume per unit of time (measured in m³/h) no matter the density of the liquid. When we deal with e.g. water supply, volume flow is the most important parameter because we need the pump to deliver a certain volume, e.g. of drinking water or water for irrigation. Throughout this book the term flow refers to volume flow.

Mass flow (Q_m)

Mass flow is the mass, which a pump moves per unit of time and is measured in kg/s. The liquid temperature has an influence on how big a mass flow the pump can move per unit of time since the liquid density changes with the temperature. In connection with heating, cooling and air-condition systems, the mass flow is an essential value to know, because the mass is the carrier of energy (see section on Heat capacity).

$$Q_m = \rho \cdot Q \quad ; \quad Q = \frac{Q_m}{\rho}$$

Examples	Unit	Water	
		at 20°C	at 120°C
Volume flow Q	m ³ /h	10	
Density	kg/m ³	998	943
Mass flow Q _m	kg/h	9980	9403
	kg/s	2.77	2.62

Fig. 2.2.1: Calculation examples

Section 2.2

Pump performance

Pressure (p)

Pressure is a measure of force per unit area. We distinguish between static pressure, dynamic pressure and total pressure. The total pressure is the sum of the static pressure and the dynamic pressure:

$$P_{tot} = P_{sta} + P_{dyn}$$

Static pressure

The static pressure p_{sta} is the pressure, which is measured with a pressure gauge placed perpendicular to the flow or in a non-moving liquid, see figure 2.2.2.

Dynamic pressure

The dynamic pressure p_{dyn} is caused by liquid velocity. Dynamic pressure cannot be measured by a normal pressure gauge, but is calculated by the following formula:

$$P_{dyn} = \frac{1}{2} \cdot \rho \cdot v^2$$

where:

ρ is the density of the liquid in [kg/m³]

v is the velocity of the liquid in [m/s]

Dynamic pressure can be converted into static pressure by reducing the liquid velocity and vice versa. Figure 2.2.3 shows a part of a system where the pipe diameter increases from D_1 to D_2 , resulting in a decrease in liquid speed from v_1 to v_2 . Assuming that there is no friction loss in the system, the sum of the static pressure and the dynamic pressure is constant throughout the horizontal pipe.

$$P_1 + \frac{1}{2} \cdot \rho \cdot v_1^2 = P_2 + \frac{1}{2} \cdot \rho \cdot v_2^2$$

So, an increase in pipe diameter, as the one shown in figure 2.2.3 results in an increase in the static head which is measured with the pressure gauge p_2 .

In most pumping systems, the dynamic pressure p_{dyn} has a minor impact on the total pressure. For example, if the velocity of a water flow is 4.5 m/s, the dynamic pressure is around 0.1 bar, which is considered insignificant in many pumping systems. Later on in this chapter, we will discuss dynamic pressure in connection with determining the head of a pump.

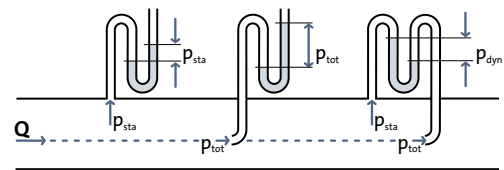


Fig. 2.2.2: How to determine the static pressure p_{sta} , the dynamic pressure p_{dyn} and the total pressure p_{tot}

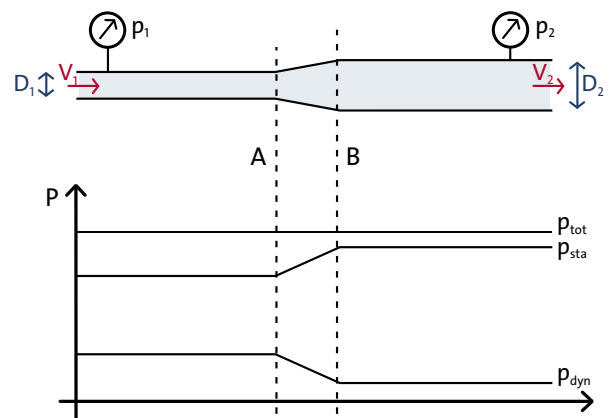


Fig. 2.2.3: The static pressure increases if the liquid velocity is reduced. The figure applies for a system with insignificant friction loss



Measuring pressure

Pressure is measured in e.g. Pa (N/m²), bar (10⁵ Pa) or PSI (lb/in²). When we deal with pressure it is important to know the point of reference for the pressure measurement. Two types of pressure are essential in connection with pressure measurement: Absolute pressure and gauge pressure:

Absolute pressure (p_{abs})

Absolute pressure is defined as the pressure above absolute vacuum, 0 atm, that is the absolute zero for pressure. Usually, the value “absolute pressure” is used in cavitation calculations.

Gauge pressure

Gauge pressure, often referred to as overpressure, is the pressure, which is higher than the normal atmospheric pressure (1 atm). Normally, pressure p is stated as gauge pressure, because most sensor and pressure gauge measurements measure the pressure difference between the system and the atmosphere. Throughout this book the term pressure refers to gauge pressure.

Head (H)

The head of a pump is an expression of how high the pump can lift a liquid. Head is measured in meter (m) and is independent on the liquid density. The following formula shows the relation between pressure (p) and head (H):

$$H = \frac{p}{\rho \cdot g}$$

where :

H is the head in [m]

p is the pressure in [Pa = N/m²]

ρ is the liquid density in [kg/m³]

g is the acceleration of gravity in [m/s²]

Normally, pressure p is measured in [bar], which equals 10⁵ Pa. However, other pressure units are used as well, see figure 2.2.4.

The relation between pressure and head is shown in figure 2.2.5 where a pump handles four different liquids.

Conversion table for pressure units						
	Pa	bar	atm*	at**	mH ₂ O	mmHg
1 Pa = 1 N/m ²	1	10 ⁻⁵	9.87 · 10 ⁻⁴	1.02 · 10 ⁻⁵	1.02 · 10 ⁻⁴	750 · 10 ⁻⁵
1 bar	10 ⁵	1	0.987	1.02	10.2	750
1 atm	1.013 · 10 ⁵	1.013	1	1.033	10.33	760
1 at = 1 kp/cm ³	0.981 · 10 ⁵	0.981	0.968	1	10	736
1 m H ₂ O	0.981 · 10 ⁴	0.0981	0.0968	0.1	1	73.6

* Physical atmosphere ** Theoretical atmosphere

Fig. 2.2.4: Conversion table for pressure units

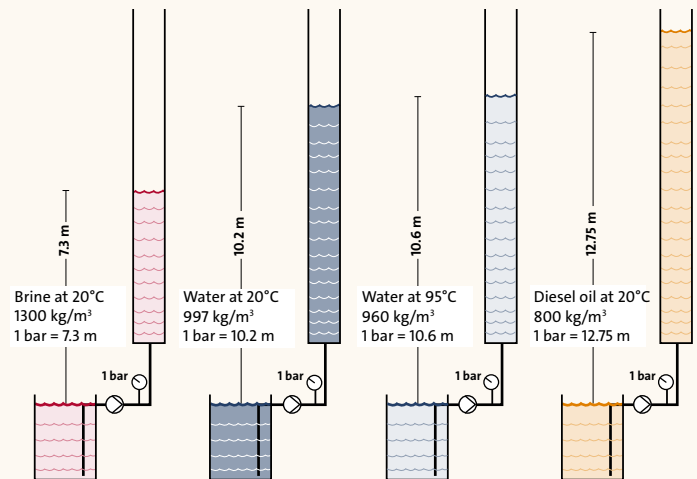


Fig. 2.2.5: Pumping four different liquids at 1 bar at the discharge side of the pump results in four different heads (m), hence four different duty points

Section 2.2

Pump performance

How to determine the head

The pump head is determined by reading the pressure on the flanges of the pump p_2 , p_1 and then convert the values into head – see figure 2.2.6. However, if a geodetic difference in head is present between the two measuring points, as it is the case in figure 2.2.6, it is necessary to compensate for the difference. Furthermore, if the port dimensions of the two measuring points differ from one another the actual head has to be corrected for this as well.

The actual pump head H is calculated by the following formula:

$$H = \frac{P_2 - P_1}{\rho \cdot g} + (h_2 - h_1) + \frac{v_2^2 - v_1^2}{2 \cdot g}$$

where :

H is the actual pump head in [m]

p is the pressure at the flanges in [Pa = N/m²]

ρ is the liquid density in [kg/m³]

g is the acceleration of gravity in [m/s²]

h is the geodetic height in [m]

v is the liquid velocity in [m/s]

The liquid velocity v is calculated by the following formula:

$$v = \frac{Q}{A} = \frac{4 \cdot Q}{\pi \cdot D^2}$$

where:

v is the velocity in [m/s]

Q is the volume flow in [m³/s]

D is the port diameter in [m]

Combining these two formulas, head H depends on the following factors: The pressure measurements p_1 and p_2 , the difference in geodetic height between the measuring points ($h_2 - h_1$), the flow through the pump Q and the diameter of the two ports D_1 and D_2 .

$$H = \frac{P_2 - P_1}{\rho \cdot g} + (h_2 - h_1) + \frac{8 \cdot Q^2}{g \cdot \pi^2} \cdot \left(\frac{1}{D_2^4} - \frac{1}{D_1^4} \right)$$

The correction due to the difference in port diameter is caused by the difference in the dynamic pressure. Instead of calculating the correction from the formula, the contribution can be read in a nomogram, see appendix F.

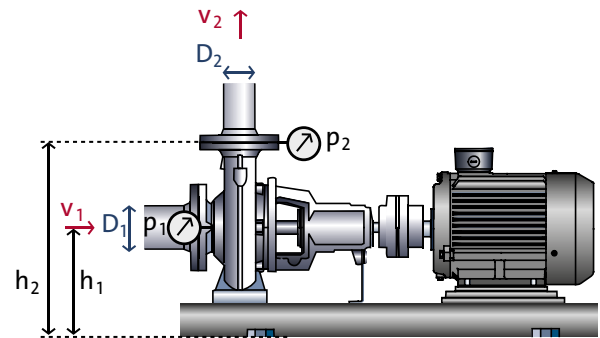


Fig. 2.2.6: Standard end-suction pump with dimension difference on suction and discharge ports



Calculation example

A pump of the same type as the one shown in figure 2.2.7 is installed in a system with the following data:

$$Q = 240 \text{ m}^3/\text{h}$$

$$p_1 = 0.5 \text{ bar}$$

$$p_2 = 1.1 \text{ bar}$$

Liquid: Water at 20°C

Suction port diameter $D_1 = 150 \text{ mm}$

Discharge port diameter $D_2 = 125 \text{ mm}$.

The difference in height between the two ports where the pressure gauges are installed is $h_2 - h_1 = 355 \text{ mm}$.

We are now able to calculate the head of the pump:

$$H = \frac{P_2 - P_1}{\rho \cdot g} + (h_2 - h_1) + \frac{8 \cdot Q^2}{g \cdot \pi^2} \cdot \left(\frac{1}{D_2^4} - \frac{1}{D_1^4} \right)$$

$$H = \frac{1.1 \cdot 10^5 - 0.5 \cdot 10^5}{998 \cdot 9.81} + (0.355) + \frac{8 \cdot \left(\frac{240}{3600} \right)^2}{9.81 \cdot \pi^2} \cdot \left(\frac{1}{0.125^4} - \frac{1}{0.150^4} \right)$$

$$H = 6.13 + 0.36 + 0.77 = 7.26 \text{ m}$$

As it appears from the calculation, the pressure difference measured by pressure gauges is about 1.1 m lower than what the pump is actually performing. This calls for an explanation. First, the deviation is caused by the difference in height between the pressure gauges (0.36 m) and second, it is caused by the difference in port dimensions, which in this case is 0.77 m.

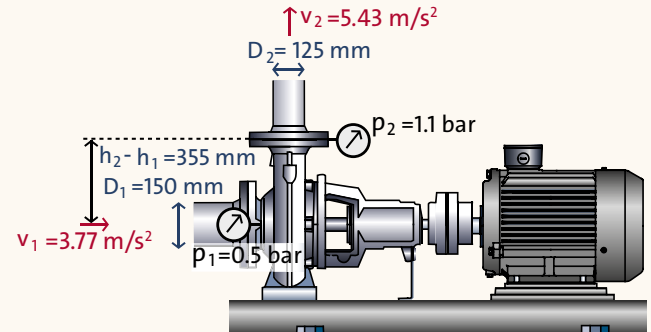


Fig. 2.2.7: Standard end-suction pump with different dimensions of suction and discharge ports (Example)

Section 2.2

Pump performance

If the pressure gauges are placed at the same geodetic height, or if a differential pressure gauge is used for the measurement, it is not necessary to compensate for the difference in height ($h_2 - h_1$). In connection with in-line pumps, where inlet and outlet are placed at the same level, the two ports often have the same diameter. For these types of pumps a simplified formula is used to determine the head:

$$H = \frac{P_2 - P_1}{\rho \cdot g}$$

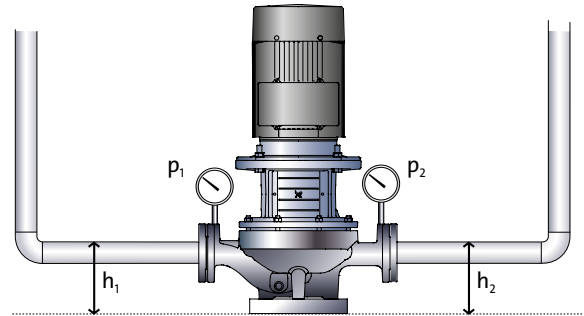


Fig.2.2.7.a: Inline pump with same geodetic height on inlet and outlet. $h_2 = h_1$

Differential pressure (Δp)

The differential pressure is the pressure difference between the pressures measured at two points, e.g. the pressure drops across valves in a system. Differential pressure is measured in the same units as pressure.

System pressure

The system pressure is the static pressure, which is present at a point in the system, when the pumps are not running. System pressure is important to consider when you deal with a closed system. The system pressure in (m) H_{sta} in the lowest point must always be higher than the height of the system in order to ensure that the system is filled with liquid and can be vented properly.

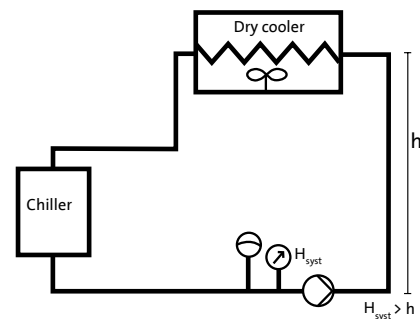


Fig.2.2.8: The system pressure H_{sta} in a closed system has to be higher than the physical height of the installation



Cavitation and NPSH

Cavitation occurs somewhere in a pump when the pressure is lower than the vapour pressure of the liquid, see figures 2.2.9 and 2.2.10.

When the pressure on the suction side drops below the vapour pressure of the liquid (figure 2.2.10 yellow dot), small vapour bubbles form. These bubbles collapse (implode) when the pressure rises (figure 2.2.10 red dot) and releases shock waves. Consequently, impellers can be damaged by the energy released. The rate of damage to the impeller depends on the properties of the material. Stainless steel is more resistant to cavitation than bronze, and bronze is more resistant to cavitation than cast iron, see section 1.6.3.

Cavitation decreases flow (Q) and head (H), which leads to reduced pump performance, see figure 2.2.11. Damage due to cavitation is often only detected when the pump is dismantled. Furthermore, cavitation results in increased noise and vibrations, which can consequently damage bearings, shaft seals and weldings.

Calculation of the risk of cavitation

To avoid cavitation, the following formula is used to calculate the maximum suction head:

$$h_{\max} = H_b - H_f - \text{NPSH} - H_v - H_s$$

h_{\max} – Maximum suction head

H_b – Atmospheric pressure at the pump site; this is the theoretical maximum suction lift, see figure 2.2.13

H_f – Friction loss in the suction pipe

NPSH = Net Positive Suction Head (is to be read at the NPSH curve at the highest operational flow), see figure 2.2.12.

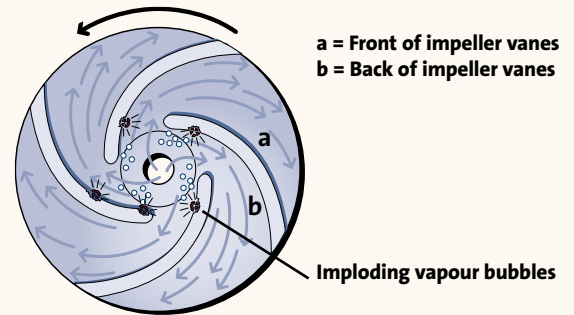


Fig.: 2.2.9: Implosion of cavitation bubbles on the back of impeller vanes

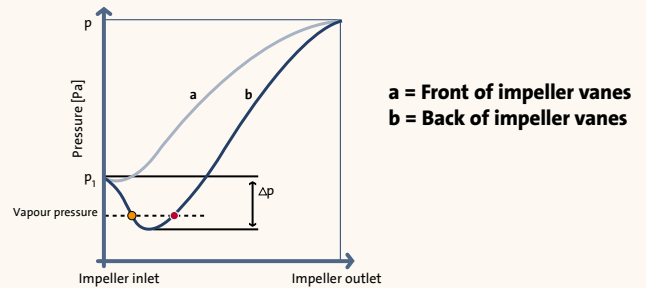


Fig.: 2.2.10: Development of pressure through a centrifugal pump

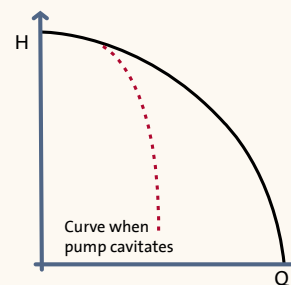


Fig.: 2.2.11: Pump curve when pump cavitates

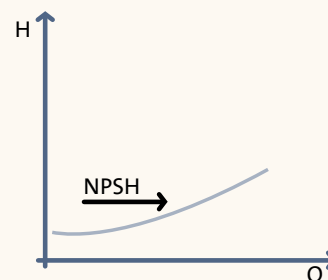


Fig.: 2.2.12: NPSH-curve

Section 2.2

Pump performance

The NPSH value indicates to what extent the pump is not able to create absolute vacuum, that is to lift a full water column 10.33 m above sea level, see figure 2.2.13.

NPSH can either be named $NPSH_r$ (required) or $NPSH_a$ (available).

$NPSH_{required}$ = The required suction head for the pump

$NPSH_{available}$ = The available suction head in the system

The NPSH value of a pump is determined by testing according to ISO 9906 and is made in the following way. The suction head is reduced while the flow is kept at a constant level. When the differential pressure has decreased by 3%, the pressure at the pump's suction side is read; and the NPSH value of the pump is defined. The testing is repeated at different flows, which form the basis of the NPSH curve in the end.

Put in another way: When the NPSH curve is reached, the level of cavitation is so high that the head of the pump has decreased by 3%.

H_v – Vapour pressure of the liquid; for more information concerning vapour pressure of water, go to appendix D.

H_s – Safety factor. H_s depends on the situation and normally varies between 0.5 m and 1 m and for liquids containing gas up to 2 m, see figure 2.2.15.

2.2.2 Electrical terms

When you want to examine a pump performance, you need to know a range of values. In this section we will present the most important electrical values: Power consumption, voltage, current and power factor.

Height above sea level (m)	Barometric pressure p_b (bar)	Water column H_b (m)	Boiling point of water ($^{\circ}C$)
0	1.013	10.33	100
500	0.935	9.73	99
1000	0.899	9.16	96
2000	0.795	8.10	93

Fig.: 2.2.13: Barometric pressure above sea level

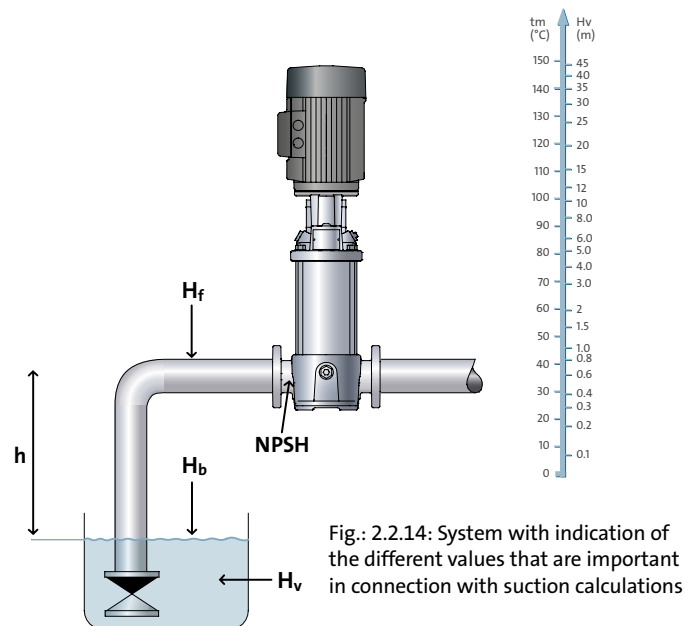


Fig.: 2.2.14: System with indication of the different values that are important in connection with suction calculations

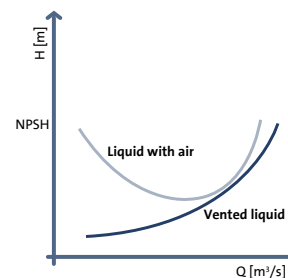


Fig.: 2.2.15: Typical NPSH curve for liquid containing gas



Power consumption (P)

Pumps are made of several components, see figure 2.2.16. The power consumption of the different components is designated in the following way:

- P₁** The power input from the mains or, put in another way, the amount of power the consumer has to pay for
- P₂** The power input to the pump or the power output from the motor. Often referred to as shaft power
- P_H** Hydraulic power – the power that the pump transfers to the liquid in the shape of flow and head

For the most common pump types, the term power consumption normally refers to P₂. Power is measured in W, kW.

Efficiency (η)

Efficiency in connection with pumps normally only covers the efficiency of the pump part η_p. A pump's efficiency is determined by several factors, for instance the shape of the pump housing, the impeller and diffuser design and the surface roughness. For typical pump units consisting of both pump and electric motor, the total efficiency η_T also includes the efficiency of the motor:

$$\eta_P = \frac{P_H}{P_2} \quad \eta_M = \frac{P_2}{P_1} \quad \eta_T = \eta_P \cdot \eta_M$$

If a frequency converter is included as well, the efficiency of the entire unit also has to incorporate the efficiency of the frequency converter:

$$\eta_T = \eta_P \cdot \eta_M \cdot \eta_{FC}$$

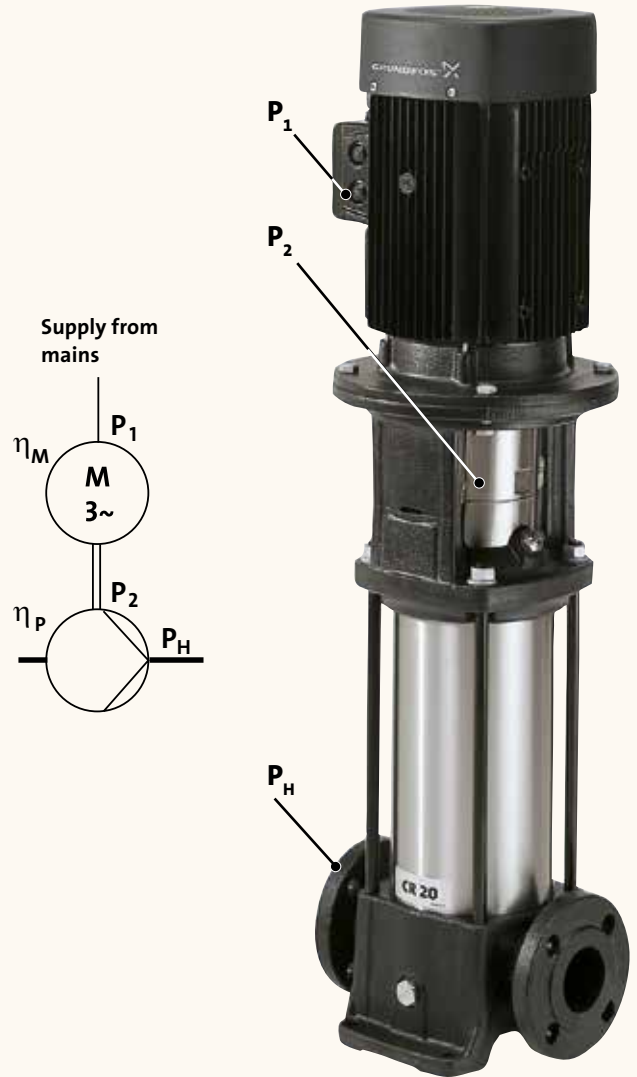


Fig. 2.2.16: Pump unit with indication of different power consumption levels

Section 2.2

Pump performance

Voltage (U)

Like pressure drives flow through a hydraulic system, voltage drives a current (I) through an electrical circuit. Voltage is measured in volts (V) and can be either direct current (DC), e.g. 1.5 V battery – or alternating current (AC), e.g. electricity supply for houses, etc. Normally, pumps are supplied with AC voltage supply. The layout of AC mains supply differs from one country to another. However, the most common layout is four wires with three phases (L1, L2, L3) and a neutral (N). Besides these four wires, a protective earth connection (PE) is added to the system as well, see figure 2.2.17. For a 3x400 V/230 V mains supply, the voltage between any two of the phases (L1, L2, L3) is 400 V. The voltage between one of the phases and neutral (N) is 230 V. The ratio between the phase-phase voltage and the phase-neutral voltage is determined by the formula on your right:

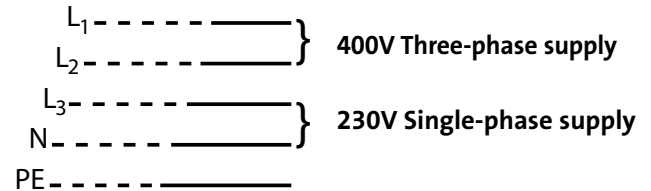


Fig. 2.2.17: Mains supply, e.g. 3 x 400 V

The voltage between any two phases (L1, L2, L3) is for a 3x400 V/230 V mains supply, 400 V. The voltage between one of the phases and neutral (N) is 230 V. The ratio between the phase-phase voltage and the phase-neutral voltage is:

$$U_{\text{Phase-Phase}} = \sqrt{3} \cdot U_{\text{Phase-Neutral}}$$

Current (I)

Current is the flow of electricity and is measured in ampere (A). The amount of current in an electrical circuit depends on the supplied voltage and the resistance/impedance in the electrical circuit.

Power (P) and power factor (cosφ or PF)

Power consumption is indeed of high importance when it comes to pumps. For pumps with standard AC motors, the power input is found by measuring the input voltage and input current and by reading the value cosφ on the motor/pump nameplate. cosφ is the phase angle between voltage and current. cosφ is also referred to as power factor (PF). The power consumption P_1 can be calculated by the formulas shown on your right depending on whether the motor is a single-phase or a three-phase motor.

AC single-phase motor, e.g. 1 x 230 V

$$P_1 = U \cdot I \cdot \cos\phi$$

AC three-phase motor, e.g. 3 x 400 V

$$P_1 = \sqrt{3} \cdot U \cdot I \cdot \cos\phi$$



2.2.3 Liquid properties

When you are making your system calculations, there are three properties you might need to know about the liquid in order to make the right calculations: Liquid temperature, density, and heat capacity.

Liquid temperature (t,T)

The liquid temperature is measured in °C (Celcius), K (Kelvin), or °F (Fahrenheit). °C and K are actually the same unit but 0°C is the freezing point of water and 0K is the absolute zero, that is -273.15°C - the lowest possible temperature. The calculation between Fahrenheit and Celcius is: °F = °C · 1.8 + 32, hence the freezing point of water is 0°C and 32°F and the boiling point is 100°C and 212°F.

Liquid density (ρ)

The density is measured in kg/m³ or kg/dm³. See appendix L.

Liquid heat capacity (C_p)

The heat capacity tells us how much additional energy a liquid can contain per mass when it is heated. Liquid heat capacity depends on temperature, see figure 2.2.18. This is used in systems for transporting energy, e.g. heating, air-con and cooling. Mixed liquids, e.g. glycol and water for air-con have a lower heat capacity than pure water hence higher flow is required to transport the same amount of energy.

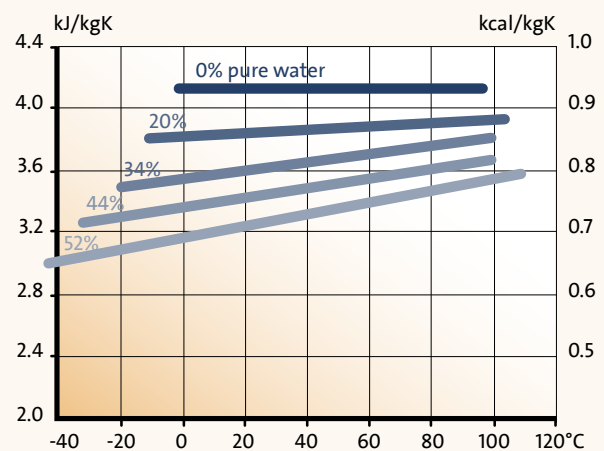


Fig. 2.2.18: Heat capacity vs. temperature for ethylene glycol

Section 3.1: System characteristics

- 3.1.1 Single resistances
- 3.1.2 Closed and open systems

Section 3.2: Pumps connected in series and parallel

- 3.2.1 Pumps in parallel
- 3.2.2 Pumps connected in series



Section 3.1

System characteristics

Previously, in section 1.1.2 we discussed the basic characteristics of pump performance curves. In this chapter we will examine the pump performance curve at different operating conditions as well as a typical system characteristic. Finally, we will focus on the interaction between a pump and a system.

A system's characteristic describes the relation between flow Q and head H in the system. The system characteristic depends on the type of system in question. We distinguish between two types: Closed and open systems.

- **Closed systems**

are circulating systems like heating or air-conditioning systems, where the pump has to overcome the friction losses in the pipes, fittings, valves, etc in the system.

- **Open systems**

are liquid transport systems like water supply systems. In such systems the pump has to deal with both the static head and overcome the friction losses in the pipes and components.

When the system characteristic is drawn in the same system of co-ordinates as the pump curve, the duty point of the pump can be determined as the point of intersection of the two curves, see figure.3.1.1.

Open and closed systems consist of resistances (valves, pipes, heat exchanger, etc) connected in series or parallel, which altogether affect the system characteristic. Therefore, before we continue our discussion on open and closed systems, we will briefly describe how these resistances affect the system characteristic.

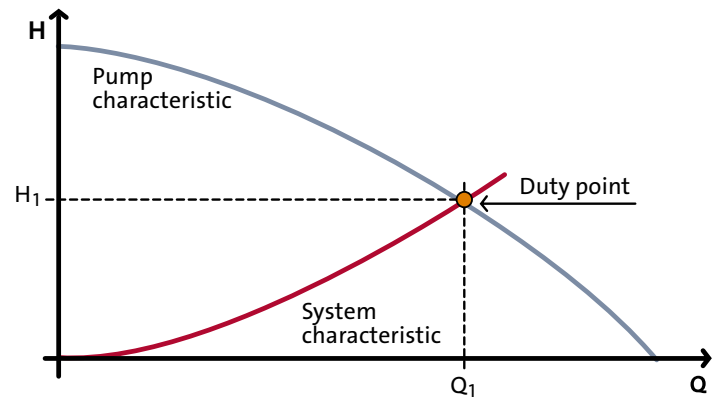


Fig. 3.1.1: The point of intersection between the pump curve and the system characteristic is the duty point of the pump



3.1.1 Single resistances

Every component in a system constitutes a resistance against the liquid flow which leads to a head loss across every single component in the system. The following formula is used to calculate the head loss ΔH :

$$\Delta H = k \cdot Q^2$$

k is a constant, which depends on the component in question and Q is the flow through the component. As it appears from the formula, the head loss is proportional to the flow in second power. So, if it is possible to lower the flow in a system, a substantial reduction in the pressure loss occurs.

Resistances connected in series

The total head loss in a system consisting of several components connected in series is the sum of head losses that each component represents. Figure 3.1.2 shows a system consisting of a valve and a heat exchanger. If we do not consider the head loss in the piping between the two components, the total head loss ΔH_{tot} is calculated by adding the two head losses:

$$\Delta H_{tot} = \Delta H_1 + \Delta H_2$$

Furthermore, figure 3.1.2 shows how the resulting curve will look and what the duty point will be if the system is a closed system with only these two components. As it appears from the figure, the resulting characteristic is found by adding the individual head losses ΔH at a given flow Q . Likewise, the figure shows that the more resistance in the system, the steeper the resulting system curve will be.

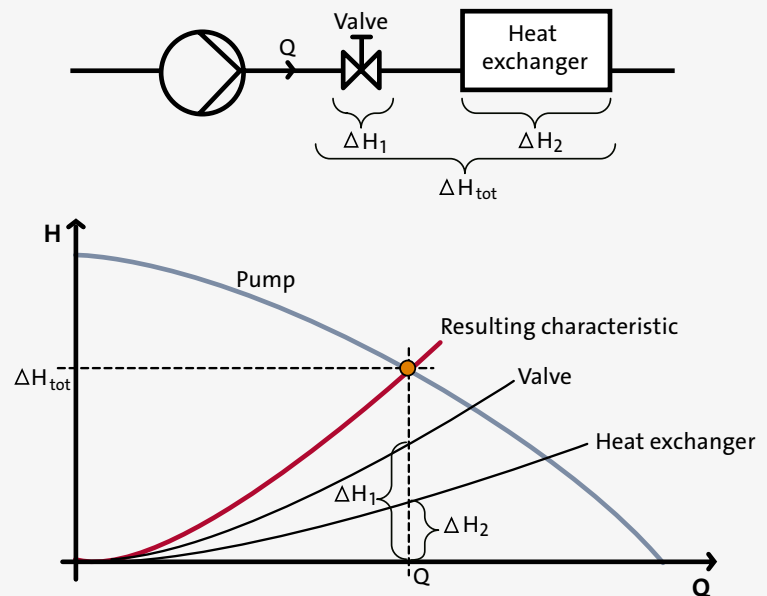


Fig. 3.1.2: The head loss for two components connected in series is the sum of the two individual head losses

Section 3.1

System characteristics

Resistances connected in parallel

Contrary to connecting components in series, connecting components in parallel result in a more flat system characteristic. The reason is that components installed in parallel reduce the total resistance in the system and thereby the head loss.

The differential pressure across the components connected in parallel is always the same. The resulting system characteristic is defined by adding all the components' individual flow rate for a specific ΔH . Figure 3.1.3 shows a system with a valve and a heat exchanger connected in parallel.

The resulting flow can be calculated by the following formula for a head loss equivalent to ΔH

$$Q_{\text{tot}} = Q_1 + Q_2$$

3.1.2 Closed and open systems

As mentioned previously, pump systems are split into two types of basic systems: Closed and open systems. In this section, we will examine the basic characteristics of these systems.

Closed systems

Typically, closed systems are systems, which transport heat energy in heating systems, air-conditioning systems, process cooling systems, etc. A common feature of these types of closed systems is that the liquid is circulated and is the carrier of heat energy. Heat energy is in fact what the system has to transport.

Closed systems are characterised as systems with pumps that only have to overcome the sum of friction losses, which are generated by all the components. Figure 3.1.4 shows a schematic drawing of a closed system where a pump has to circulate water from a heater through a control valve to a heat exchanger.

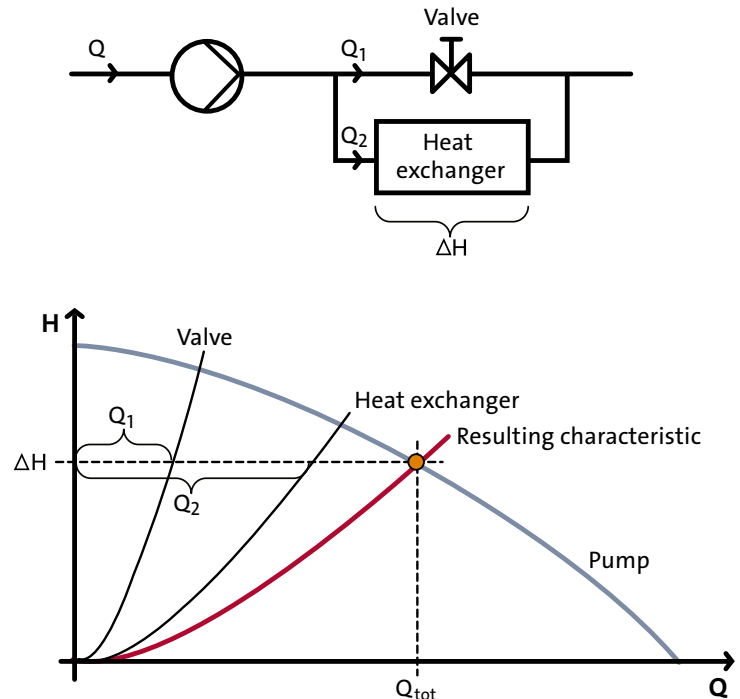


Fig. 3.1.3: Components connected in parallel reduce the resistance in the system and result in a more flat system characteristic

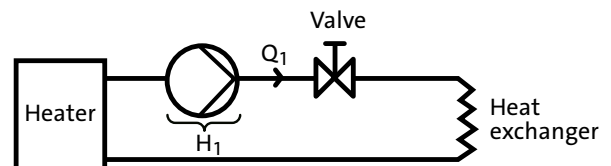


Fig. 3.1.4: Schematic drawing of a closed system



All these components together with the pipes and fittings result in a system characteristic as the one shown in figure 3.1.5. The required pressure in a closed system (which the system curve illustrates) is a parabola starting in the point (Q,H) = (0,0) and is calculated by the following formula:

$$H = k \cdot Q^2$$

As the formula and curve indicate, the pressure loss is approaching zero when the flow drops.

Open systems

Open systems are systems, where the pump is used to transport liquid from one point to another, e.g. water supply systems, irrigation systems, industrial process systems. In such systems the pump has to deal with both the geodetic head of the liquid and to overcome the friction losses in the pipes and the system components.

We distinguish between two types of open system:

- Open systems where the total required geodetic lift is positive.
- Open systems where the total required geodetic lift is negative.

Open system with positive geodetic head

Figure 3.1.6 shows a typical open system with positive geodetic lift. A pump has to transport water from a break tank at ground level up to a roof tank on the top of a building. First of all, the pump has to provide a head higher than the geodetic head of the water (h). Secondly, the pump has to provide the necessary head to overcome the total friction loss between the two tanks in piping, fittings, valves, etc (H_f). The pressure loss depends on the amount of flow, see figure 3.1.7.

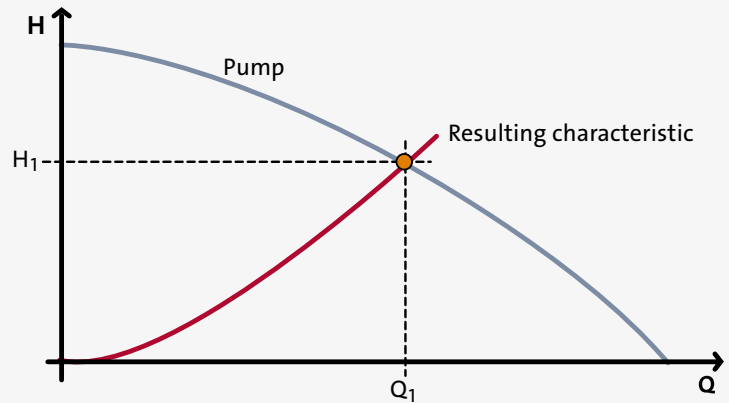


Fig. 3.1.5: The system characteristic for a closed system is a parabola starting in point (0,0)

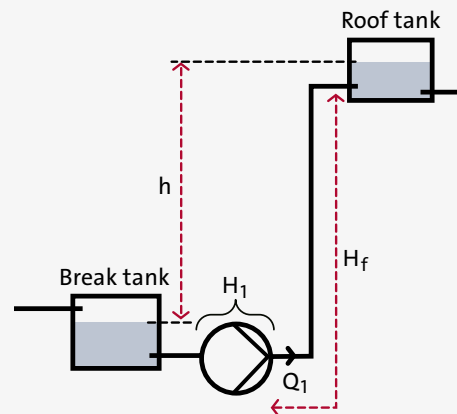


Fig. 3.1.6: Open system with positive geodetic lift

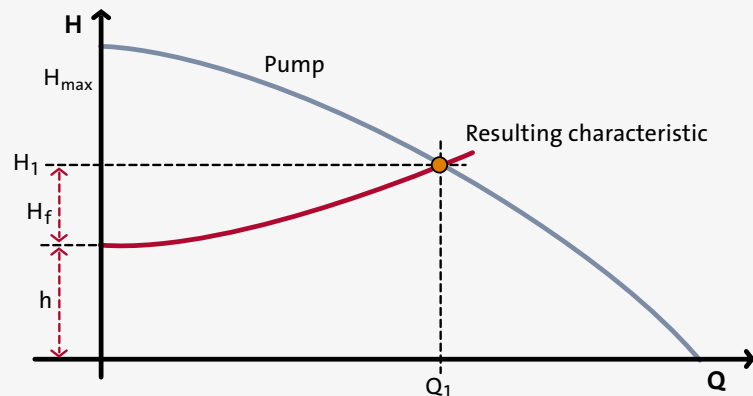


Fig. 3.1.7: System characteristic together with the pump performance curve for the open system in figure 3.1.6

Section 3.1

System characteristics

The figure shows that in an open system no water flows if the maximum head (H_{max}) of the pump is lower than the geodetic head (h). Only when $H > h$, water will start to flow from the break tank to the roof tank. The system curve also shows that the lower the flow rate, the lower the friction loss (H_f) and consequently the lower the power consumption of the pump.

So, the flow (Q_1) and the pump size have to match the need for the specific system. This is in fact a rule-of-thumb for liquid transport systems: A larger flow leads to a higher pressure loss, whereas a smaller flow leads to a smaller pressure loss and consequently a lower energy consumption.

Open system with negative geodetic lift

A typical example of an open system with negative geodetic lift is a pressure booster system, e.g. in a water supply system. The geodetic head (h) from the water tank brings water to the consumer - the water flows, although the pump is not running. The difference in height between the liquid level in the tank and the altitude of the water outlet (h) results in a flow equivalent to Q_0 . However, the head is insufficient to ensure the required flow (Q_1) to the consumer. Therefore, the pump has to boost the head to the level (H_1) in order to compensate for the friction loss (H_f) in the system. The system is shown in figure 3.1.8 and the system characteristic together with the pump performance curve are shown in figure 3.1.9.

The resulting system characteristic is a parabolic curve starting at the H-axis in the point $(0, -h)$.

The flow in the system depends on the liquid level in the tank. If we reduce the water level in the tank the height (h) is reduced. This results in a modified system characteristic and a reduced flow in the system, see figure 3.1.9.

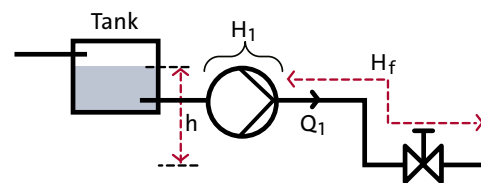


Fig. 3.1.8: Open system with negative geodetic lift

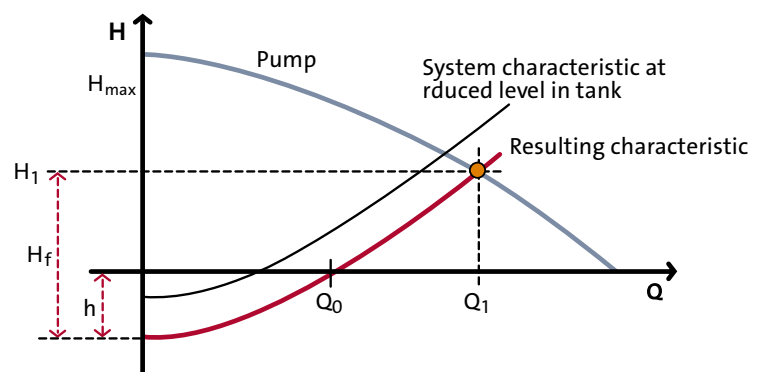


Fig. 3.1.9: System characteristic together with the pump performance curve for the open system in figure 3.1.8

Section 3.2

Pumps connected in series and parallel



To extend the total pump performance in a system, pumps are often connected in series or parallel. In this section we will concentrate on these two ways of connecting pumps.

3.2.1 Pumps in parallel

Pumps connected in parallel are often used when

- the required flow is higher than what one single pump can supply
- the system has variable flow requirements and when these requirements are met by switching the parallel-connected pumps on and off.

Normally, pumps connected in parallel are of similar type and size. However, the pumps can be of different size, or one or several pumps can be speed-controlled and thereby have different performance curves.

To avoid bypass circulation in pumps which are not running, a non-return valve is connected in series with each of the pumps. The resulting performance curve for a system consisting of several pumps in parallel is determined by adding the flow, which the pumps deliver at a specific head.

Figure 3.2.1 shows a system with two identical pumps connected in parallel. The system's total performance curve is determined by adding Q_1 and Q_2 for every value of head which is the same for both pumps, $H_1=H_2$. Because the pumps are identical the resulting pump curve has the same maximum head H_{\max} but the maximum flow Q_{\max} is twice as big. For each value of head the flow is the double as for a single pump in operation:

$$Q = Q_1 + Q_2 = 2 Q_1 = 2 Q_2$$

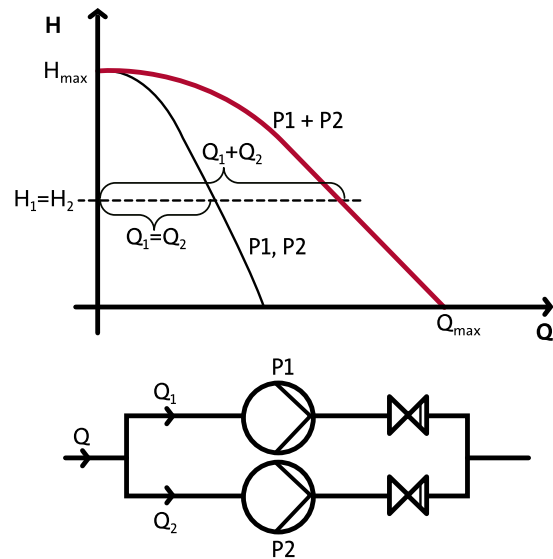


Fig. 3.2.1: Two pumps connected in parallel with similar performance curves

Section 3.2

Pumps connected in series and parallel

Figure 3.2.2 shows two different sized pumps connected in parallel. When adding Q_1 and Q_2 for a given head $H_1=H_2$, the resulting performance curve is defined. The hatched area in figure 3.2.2 shows that P1 is the only pump to supply in that specific area, because it has a higher maximum head than P2.

Speed-controlled pumps connected in parallel

The combination of pumps connected in parallel and speed-controlled pumps is a very useful way to achieve efficient pump performance when the flow demand varies. The method is common in connection with water supply / pressure boosting systems. Later in chapter 4, we will discuss speed-controlled pumps in detail.

A pumping system consisting of two speed-controlled pumps with the same performance curve covers a wide performance range, see figure 3.2.3.

One single pump is able to cover the required pump performance up until Q_1 . Above Q_1 both pumps have to operate to meet the performance needed. If both pumps are running at the same speed the resulting pump curves look like the orange curves shown in figure 3.2.3.

Please note that the duty point indicated at Q_1 is obtained with one pump running at full speed. However, the duty point can also be achieved when two pumps are running at reduced speed. This situation is shown in figure 3.2.4 (orange curves). The figure also compares the two situations with regard to efficiency. The duty point for one single pump running at full speed results in a bad pump efficiency mainly because the duty point is located far out on the pump curve. The total efficiency is much higher when two pumps run at reduced speed, although the maximum efficiency of the pumps decreases slightly at reduced speed.

Even though one single pump is able to maintain the required flow and head, it is sometimes necessary due to efficiency and thus energy consumption to use both pumps at the same time. Whether to run one or two pumps depends on the actual system characteristic and the pump type in question.

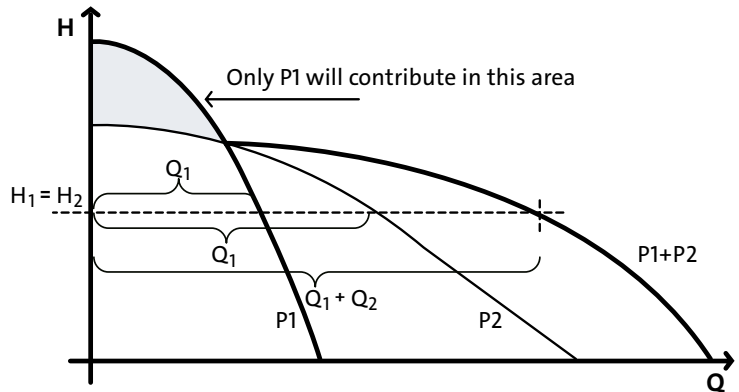


Fig 3.2.2: Two pumps connected in parallel with unequal performance curves

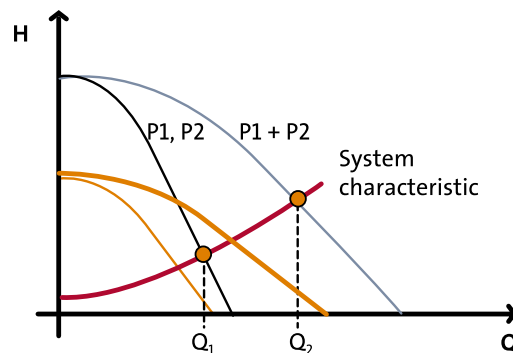


Fig. 3.2.3: Two speed-controlled pumps connected in parallel (same size). The orange curve shows the performance at reduced speed

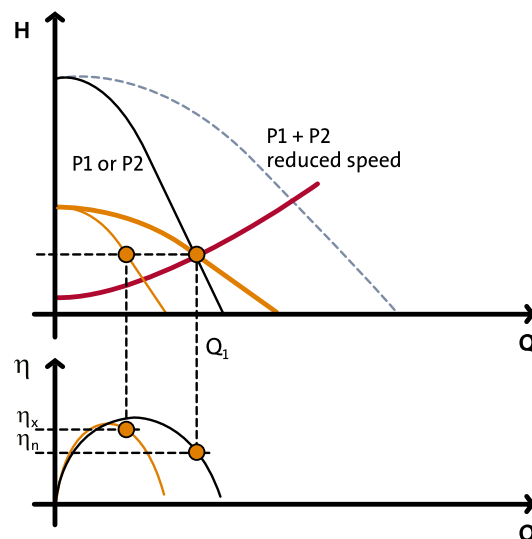


Fig. 3.2.4: One pump at full speed compared to two pumps at reduced speed. In this case the two pumps have the highest total efficiency



3.2.2. Pumps connected in series

Normally, pumps connected in series are used in systems where a high pressure is required. This is also the case for multistage pumps which are based on the series principle, that is one stage equals one pump. Figure 3.2.5 shows the performance curve of two identical pumps connected in series. The resulting performance curve is made by marking the double head for each flow value in the system of co-ordinates. This results in a curve with the double maximum head ($2 \cdot H_{\max}$) and the same maximum flow (Q_{\max}) as each of the single pumps.

Figure 3.2.6 shows two different sized pumps connected in series. The resulting performance curve is found by adding H_1 and H_2 at a given common flow $Q_1 = Q_2$.

The hatched area in figure 3.2.6 shows that P2 is the only pump to supply in that specific area because it has a higher maximum flow than P1.

As discussed in section 3.2.1, unequal pumps can be a combination of different sized pumps or of one or several speed-controlled pumps. The combination of a fixed speed pump and a speed-controlled pump connected in series is often used in systems where a high and constant pressure is required. The fixed speed pump supplies the liquid to the speed-controlled pump whose output is controlled by a pressure transmitter PT, see figure 3.2.7.

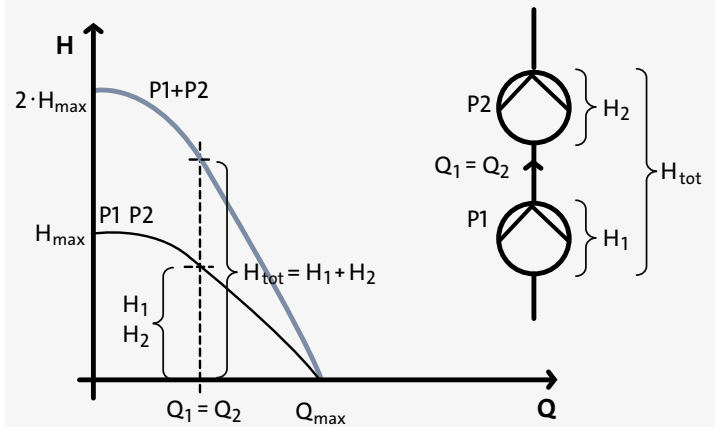


Fig. 3.2.5: Two equal sized pumps connected in series

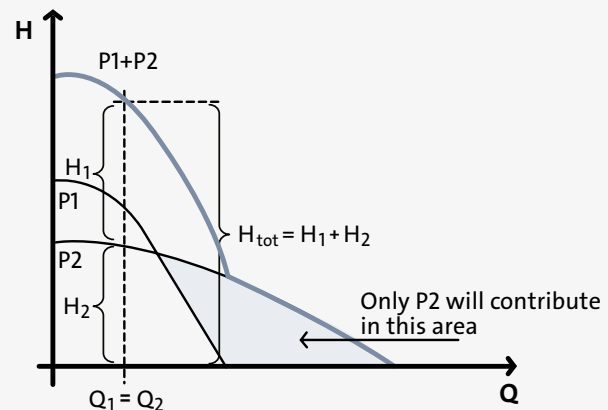


Fig. 3.2.6: Two different sized pumps connected in series

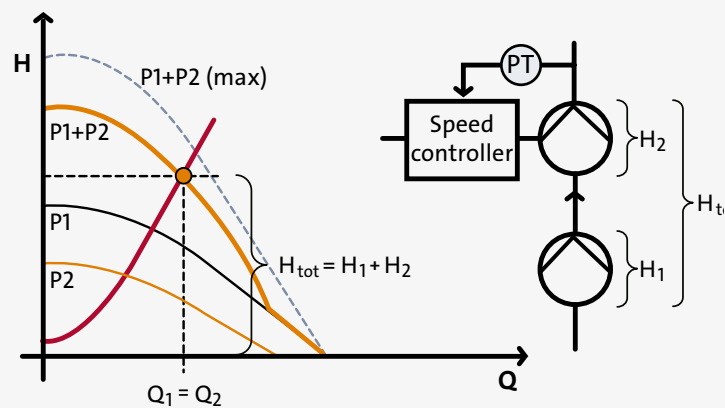


Fig. 3.2.7: Equal sized fixed speed pump and speed-controlled pump connected in series. A pressure transmitter PT together with a speed controller is making sure that the pressure is constant at the outlet of P2.



Section 4.1: Adjusting pump performance

- 4.1.1 Throttle control
- 4.1.2 Bypass control
- 4.1.3 Modifying impeller diameter
- 4.1.4 Speed control
- 4.1.5 Comparison of adjustment methods
- 4.1.6 Overall efficiency of the pump system
- 4.1.7 Example: Relative power consumption when the flow is reduced by 20%

Section 4.2: Speed-controlled pump solutions

- 4.2.1 Constant pressure control
- 4.2.2 Constant temperature control
- 4.2.3 Constant differential pressure in a circulating system
- 4.2.4 Flow-compensated differential pressure control

Section 4.3: Advantages of speed control

Section 4.4: Advantages of pumps with integrated frequency converter

- 4.4.1 Performance curves of speed-controlled pumps
- 4.4.2 Speed-controlled pumps in different systems

Section 4.5: Frequency converter

- 4.5.1 Basic function and characteristics
- 4.5.2 Components of the frequency converter
- 4.5.3 Special conditions regarding frequency converters

Section 4.1

Adjusting pump performance

When selecting a pump for a given application it is important to choose one where the duty point is in the high-efficiency area of the pump. Otherwise, the power consumption of the pump is unnecessarily high – see figure 4.1.1.

However, sometimes it is not possible to select a pump that fits the optimum duty point because the requirements of the system change or the system curve changes over time.

Therefore, it can be necessary to adjust the pump performance so that it meets the changed requirements.

The most common methods of changing pump performance are:

- Throttle control
- Bypass control
- Modifying impeller diameter
- Speed control

Choosing a method of adjusting the pump performance is based on an evaluation of the initial investment together with the operating costs of the pump. All methods can be carried out continuously during operation apart from the modifying impeller diameter–method. Often, oversized pumps are selected for the system and therefore it is necessary to limit the performance – first of all, the flow rate and in some applications the maximum head.

On the following pages you can read about the four adjusting methods.

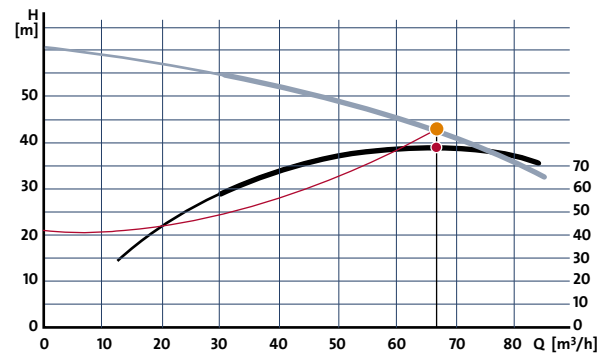


Fig.: 4.1.1: When selecting a pump it is important to choose a pump where the duty point is within the high efficiency area.



4.1.1 Throttle control

A throttle valve is placed in series with the pump making it possible to adjust the duty point. The throttling results in a reduction of flow, see figure 4.1.2. The throttle valve adds resistance to the system and raises the system curve to a higher position. Without the throttle valve, the flow is Q_2 . With the throttle valve connected in series with the pump, the flow is reduced to Q_1 .

Throttle valves can be used to limit the maximum flow. By adding the valve, the maximum possible flow in the system is limited. In the example, the flow will never be higher than Q_3 , even if the system curve is completely flat – meaning no resistance at all in the system. When the pump performance is adjusted by the throttling method, the pump will deliver a higher head than necessary for that particular system.

$$H_p = H_s + H_v$$

If the pump and the throttle valve are replaced by a smaller pump, the pump will be able to meet the wanted flow Q_1 , but at a lower pump head and consequently a lower power consumption, see figure 4.1.2.

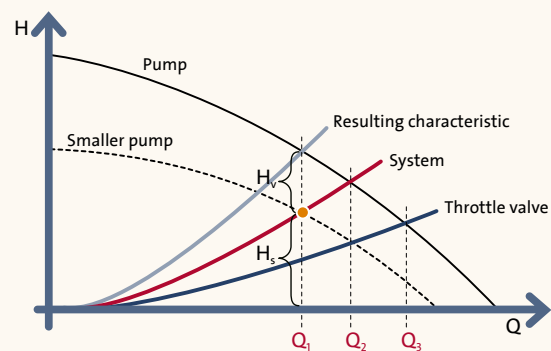
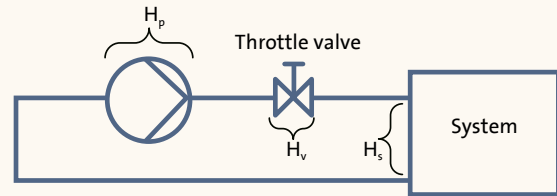


Fig.: 4.1.2: The throttle valve increases the resistance in the system and consequently reduces the flow.

4.1.2 Bypass control

Instead of connecting a valve in series with the pump, a bypass valve across the pump can be used to adjust the pump performance, see figure 4.1.3.

Compared to the throttle valve, installing a bypass valve will result in a certain minimum flow Q_{BP} in the pump, independent on the system characteristics. The flow Q_p is the sum of the flow in the system Q_s and the flow in the bypass valve Q_{BP} .

$$Q_p = Q_s + Q_{BP}$$

The bypass valve will introduce a maximum limit of head supplied to the system H_{max} , see figure 4.1.3. Even when the required flow in the system is zero, the pump will never run against a closed valve. Like it was in the case with the throttling valve, the required flow Q_s can be met by a smaller pump and no bypass valve; the result being a lower flow and consequently a lower energy consumption.

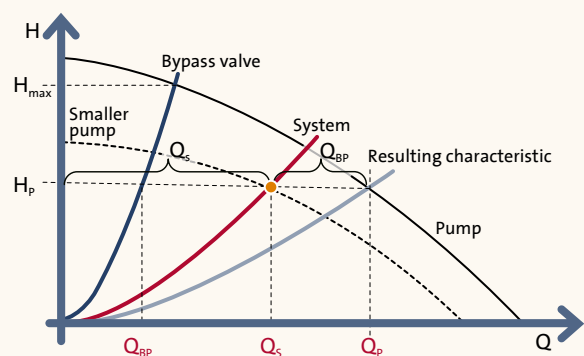
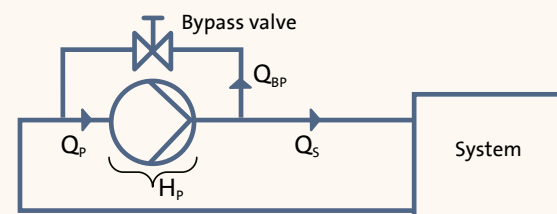


Fig.: 4.1.3: The bypass valve bypasses part of the flow from the pump and thereby reduces the flow in the system

Section 4.1

Adjusting pump performance

4.1.3 Modifying impeller diameter

Another way of adjusting the performance of a centrifugal pump is by modifying the impeller diameter in the pump meaning reducing the diameter and consequently reducing the pump performance. Obviously, reducing the impeller diameter cannot be done while the pump is operating. Compared to the throttling and bypass methods, which can be carried out during operation, modifying the impeller diameter has to be done in advance before the pump is installed or in connection with service. The following formulas show the relation between the impeller diameter and the pump performance:

$$\frac{Q_n}{Q_x} = \left(\frac{D_n}{D_x}\right)^2; \frac{H_n}{H_x} = \left(\frac{D_n}{D_x}\right)^2; \frac{P_n}{P_x} = \left(\frac{D_n}{D_x}\right)^4; \frac{\eta_n}{\eta_x} = 1$$

Please note that the formulas are an expression of an ideal pump. In practice, the pump efficiency decreases when the impeller diameter is reduced. For minor changes of the impeller diameter $D_x > 0.8 \cdot D_n$, the efficiency is only reduced by a few %-points. The degree of efficiency reduction depends on pump type and duty point (check specific pump curves for details).

As it appears from the formulas, the flow and the head change with the same ratio – that is the ratio change of the impeller diameter in second power. The duty points following the formulas are placed on a straight line starting in (0,0). The change in power consumption is following the diameter change in fourth power.

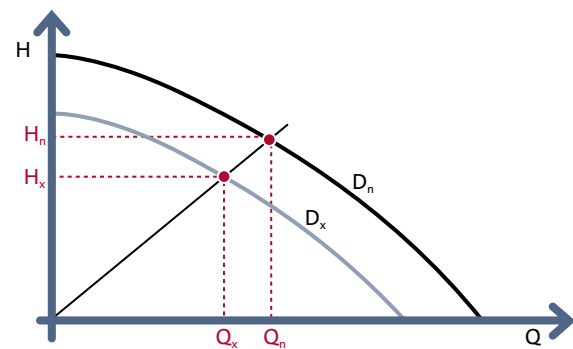
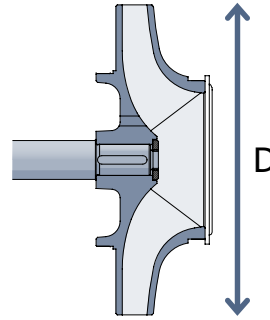


Fig. 4.1.4: Change in pump performance when the impeller diameter is reduced

4.1.4 Speed control

The last method of controlling the pump performance that we will cover in this section is the variable speed control method. Speed control by means of a frequency converter is without no doubt the most efficient way of adjusting pump performance exposed to variable flow requirements.



The following equations apply with close approximation to how the change of speed of centrifugal pumps influences the performance of the pump:

$$\frac{Q_n}{Q_x} = \frac{n_n}{n_x}; \frac{H_n}{H_x} = \left(\frac{n_n}{n_x}\right)^2; \frac{P_n}{P_x} = \left(\frac{n_n}{n_x}\right)^3; \frac{\eta_n}{\eta_x} = 1$$

The affinity laws apply on condition that the system characteristic remains unchanged for n_n and n_x and forms a parabola through (0,0) – see section 3.1.1. The power equation furthermore implies that the pump efficiency is unchanged at the two speeds.

The formulas in figure 4.1.5 show that the pump flow (Q) is proportional to the pump speed (n). The head (H) is proportional to the second power of the speed (n) whereas the power (P) is proportional to the third power of the speed. In practice, a reduction of the speed will result in a slight fall in efficiency. The efficiency at reduced speed (n_x) can be estimated by the following formula, which is valid for speed reduction down to 50% of the maximum speed:

$$\eta_x = 1 - (1 - \eta_n) \cdot \left(\frac{n_n}{n_x}\right)^{0.1}$$

Finally, if you need to know precisely how much power you can save by reducing the pump speed, you have to take the efficiency of the frequency converter and the motor into account.

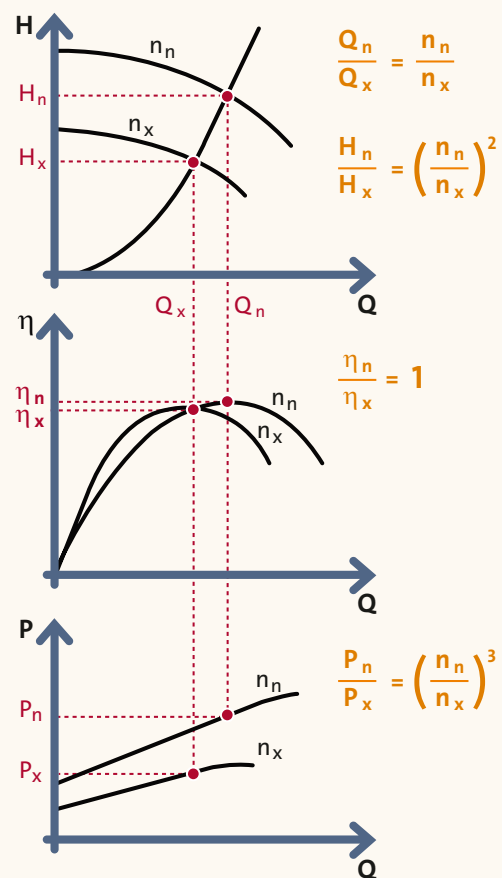


Fig. 4.1.5: Pump parameters for different affinity equations

Section 4.1

Adjusting pump performance

4.1.5 Comparison of adjustment methods

Now that we have described the four different ways of changing the performance of a centrifugal pump, we will have a look at how they differ from one another.

When we consider the pump and its performance-changing device as one unit, we can observe the resulting QH-characteristic of this device and compare the result of the different systems.

Throttle control

The throttling method implies a valve connected in series with a pump, see figure 4.1.6a. This connection acts as a new pump at unchanged maximum head but reduced flow performance. The pump curve H_n , the valve curve and the curve covering the complete system - H_x , see figure 4.1.6b.

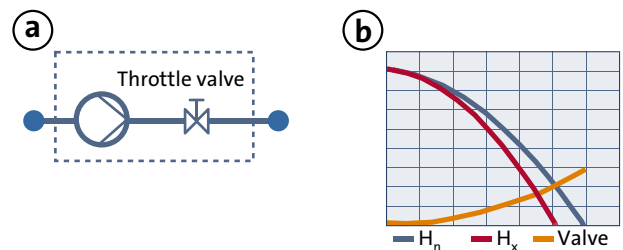


Fig. 4.1.6: Throttle valve connected in series with a pump

Bypass control

When a valve is connected across the pump, see figure 4.1.7a, this connection acts as a new pump at reduced maximum head and a QH curve with a changed characteristic. The curve will tend to be more linear than quadratic, see figure 4.1.7b

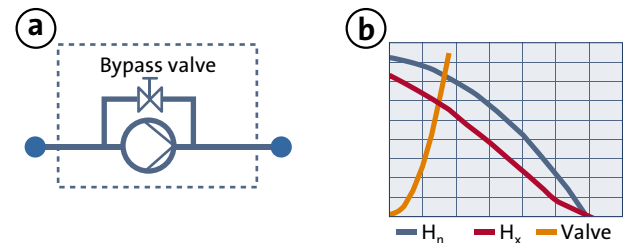


Fig. 4.1.7: Bypass valve connected across the pump

Modifying impeller diameter

The impeller-reducing method does not imply any extra components. Figure 4.1.8 shows the reduced QH curve (H_x) and the original curve characteristics (H_n).

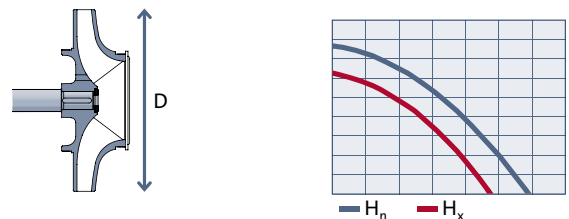


Fig. 4.1.8: Impeller diameter adjustment

Speed control

The speed control method (figure 1.4.9) results in a new QH curve at reduced head and flow. The characteristics of the curves remain the same. However, when speed is reduced the curves become more flat, as the head is reduced to a higher degree than the flow.

Compared to the other methods the speed control method also makes it possible to extend the performance range of the pump above the nominal QH curve, simply by increasing the speed above nominal speed level of the pump, see the H_y curve in figure 4.1.9. If this over-synchronous operation is used, the size of the motor has to be taken into account.

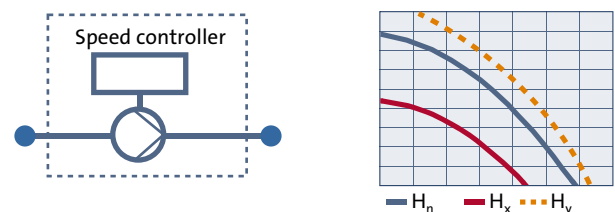


Fig. 4.1.9: Speed controller connected to a pump



4.1.6 Overall efficiency of the pump system

Both the throttling and the bypass method introduce some hydraulic power losses in the valves ($P_{\text{loss}} = k Q H$). Therefore, the resulting efficiency of the pumping system is reduced. Reducing the impeller size in the range of $D_x/D_n > 0.8$ does not have a significant impact on the pump efficiency. Therefore, this method does not have a negative influence on the overall efficiency of the system.

The efficiency of speed-controlled pumps is only affected to a limited extent, as long as the speed reduction does not drop below 50% of the nominal speed. Later on, we will discover that the efficiency has only reduced a few %-points, and that it does not have an impact on the overall running economy of speed-controlled solutions, see figure 1.4.17 under section 1.4.4

4.1.7 Example: Relative power consumption when the flow is reduced by 20 %

In a given installation the flow has to be reduced from $Q = 60 \text{ m}^3/\text{h}$ to $50 \text{ m}^3/\text{h}$. In the original starting point ($Q = 60 \text{ m}^3/\text{h}$ and $H = 70 \text{ m}$) the power input to the pump is set relatively to 100%. Depending on the method of performance adjustment, the power consumption reduction will vary. Now, let us have a look at how the power consumption affects each of the performance adjustment methods.

Section 4.1

Adjusting pump performance

Throttle control

The power consumption is reduced to about 94% when the flow drops. The throttling results in an increased head, see figure 4.1.10. The maximum power consumption is for some pumps at a lower flow than the maximum flow. If this is the case, the power consumption increases because of the throttle.

Bypass control

To reduce the flow in the system, the valve has to reduce the head of the pump to 55 m. This can only be done by increasing the flow in the pump. As it appears from figure 4.1.11, the flow is consequently increased to 81 m³/h, which results in an increased power consumption of up to 10% above the original consumption. The degree of increase depends on the pump type and the duty point. Therefore, in some cases, the increase in P_2 is equal to zero and in a few rare cases P_2 might even decrease a little.

Modifying impeller diameter

When the impeller diameter is reduced, both the flow and the head of the pump drop. By a flow reduction of 20%, the power consumption is reduced to around 67% of its original consumption, see figure 4.1.12.

Speed control

When the speed of the pump is controlled, both the flow and the head are reduced, see figure 4.1.13. Consequently, the power consumption has reduced to around 65% of the original consumption.

When it comes to obtaining the best possible efficiency, the impeller diameter adjustment method or the speed control method of the pump are the best suited for reducing the flow in the installation. When the pump has to operate in a fixed, modified duty point, the impeller diameter adjustment method is the best solution. However, when we deal with an installation, where the flow demand varies, the speed-controlled pump is the best solution.

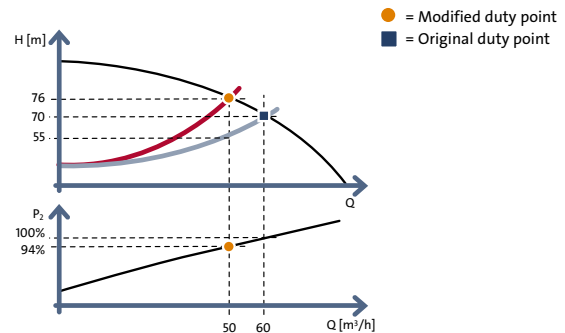


Fig. 4.1.10: Relative power consumption - throttle control

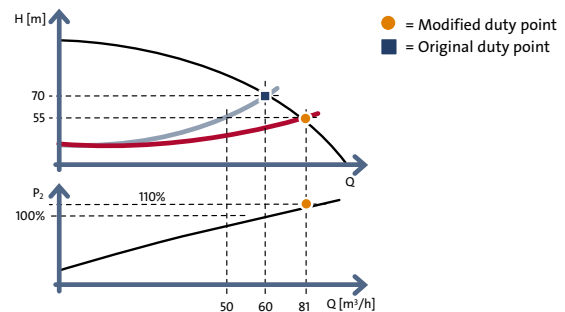


Fig. 4.1.11: Relative power consumption - bypass control

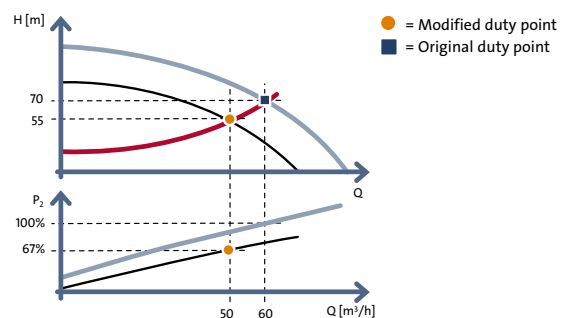


Fig. 4.1.12: Relative power consumption - modifying impeller diameter

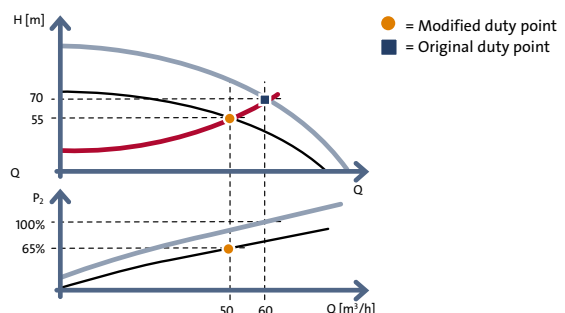


Fig. 4.1.13: Relative power consumption - speed control

Summary

Figure 4.1.14 gives an overview of the different adjustment methods that we have presented in the previous section. Each method has its pros and cons which have to be taken into account when choosing an adjustment method for a system.

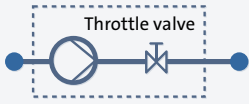
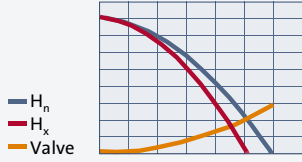
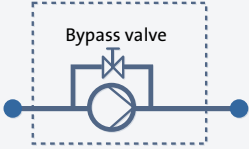
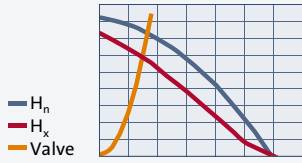
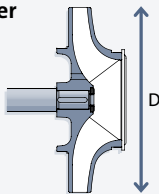
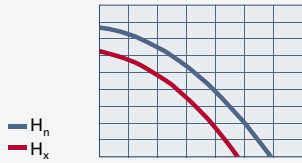
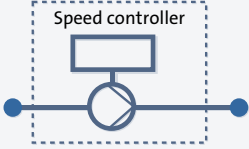
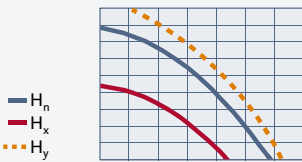
Method	Continuous adjustment possible?	The resulting performance curve will have	Overall efficiency of the pump system	Relative power consumption by 20% reduction in flow
Throttle control 	Yes	Reduced Q 	Considerably reduced	94%
Bypass control 	Yes	Reduced H and changed curve 	Considerably reduced	110%
Modifying impeller diameter 	No	Reduced Q and H 	Slightly reduced	67%
Speed control 	Yes	Reduced Q and H 	Slightly reduced	65%

Fig. 4.1.14: Characteristics of adjustment methods.

Section 4.2

Speed-controlled pump solutions

As discussed in the previous section, speed control of pumps is an efficient way of adjusting pump performance to the system. In this section we will discuss the possibilities of combining speed-controlled pumps with PI-controllers and sensors measuring system parameters, such as pressure, differential pressure and temperature. On the following pages, the different options will be presented by examples.

4.2.1 Constant pressure control

A pump has to supply tap water from a break tank to different taps in a building.

The demand for tap water is varying, so therefore the system characteristic varies according to the required flow. Due to comfort and energy savings a constant supply pressure is recommended.

As it appears from figure 4.2.1, the solution is a speed-controlled pump with a PI-controller. The PI-controller compares the needed pressure p_{set} with the actual supply pressure p_1 , measured by a pressure transmitter PT. If the actual pressure is higher than the setpoint, the PI-controller reduces the speed and consequently the performance of the pump until $p_1 = p_{set}$. Figure 4.2.1 shows what happens when the flow is reduced from Q_{max} to Q_1 .

The controller sees to it that the speed of the pump is reduced from n_n to n_x in order to ensure that the required discharge pressure is $p_1 = p_{set}$. The pump installation ensures that the supply pressure is constant in the flow range of 0 - Q_{max} . The supply pressure is independent on the level (h) in the break tank. If h changes, the PI-controller adjusts the speed of the pump so that p_1 always corresponds to the setpoint.

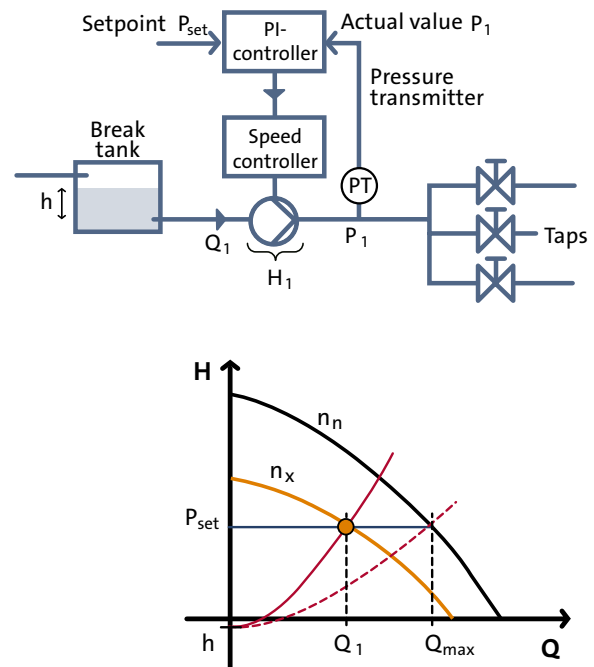


Fig. 4.2.1: Water supply system with speed-controlled pump delivering constant pressure to the system



4.2.2 Constant temperature control

Performance adjustment by means of speed control is suitable for a number of industrial applications. Figure 4.2.2 shows a system with an injection moulding machine which has to be water-cooled to ensure high quality production.

The machine is cooled with water at 15°C from a cooling plant. To ensure that the moulding machine runs properly and is cooled sufficiently, the return pipe temperature has to be kept at a constant level; $t_r = 20^\circ\text{C}$. The solution is a speed-controlled pump controlled by a PI-controller. The PI-controller compares the needed temperature t_{set} with the actual return pipe temperature t_r , which is measured by a temperature transmitter TT. This system has a fixed system characteristic and therefore the duty point of the pump is located on the curve between Q_{min} and Q_{max} . The higher the heat loss in the machine, the higher the flow of cooling water needed to ensure that the return pipe temperature is kept at a constant level of 20°C.

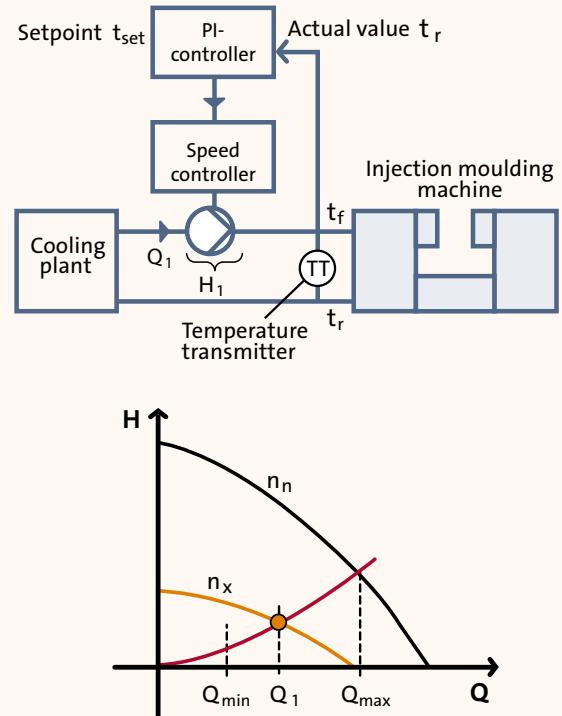


Fig. 4.2.2: System with injection moulding machine and temperature-controlled circulator pump ensuring a constant return pipe temperature

4.2.3 Constant differential pressure in a circulating system

Circulating systems (closed systems), see chapter 3, are well-suited for speed-controlled pump solutions. It is an advantage that circulating systems with variable system characteristic are fitted with a differential pressure-controlled circulator pump, see figure 4.2.3.

The figure shows a heating system consisting of a heat exchanger where the circulated water is heated up and delivered to three consumers, e.g. radiators, by a speed-controlled pump. A control valve is connected in series at each consumer to control the flow according to the heat requirement.

The pump is controlled according to a constant differential pressure, measured across the pump. This means that the pump system offers constant differential pressure in the Q -range of $0 - Q_{max}$, depicted as the horizontal line in figure 4.2.3.

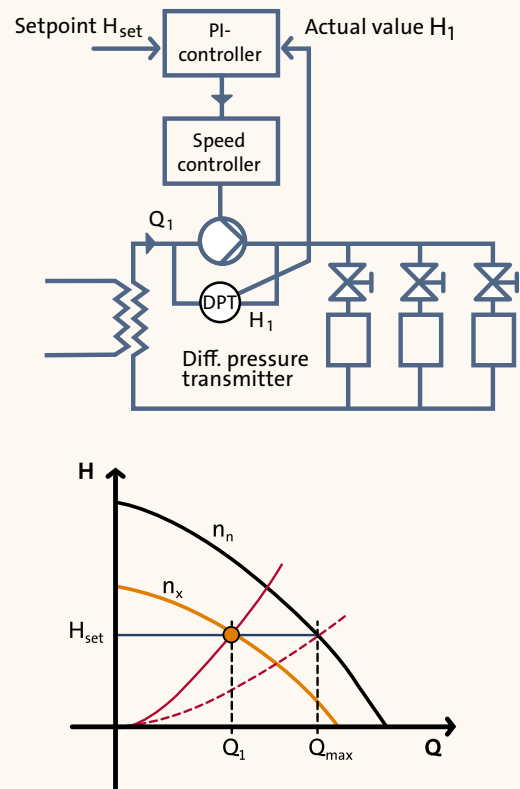


Fig. 4.2.3: Heating system with speed-controlled circulator pump delivering constant differential pressure to the system

Section 4.2

Speed-controlled pump solutions

4.2.4 Flow-compensated differential pressure control

The main function of the pumping system in figure 4.2.4 is to maintain a constant differential pressure across the control valves at the consumers, e.g. radiators. In order to do so, the pump has to be able to overcome friction losses in pipes, heat exchangers, fittings, etc.

As we discussed in chapter 3, the pressure loss in a system is proportional to the flow in second power. The best way to control a circulator pump in a system like the one shown in the figure on your right, is to allow the pump to deliver a pressure, which increases when the flow increases.

When the demand of flow is low, the pressure losses in the pipes, heat exchangers, fittings, etc are low as well, and the pump only supplies a pressure equivalent to what the control valve requires, $H_{set} - H_f$. When the demand of flow increases, the pressure losses increase in second power and therefore the pump has to increase the delivered pressure; depicted as the blue curve in figure 4.2.4.

Such a pumping system can be designed in two different ways:

- The differential pressure transmitter is placed across the pump and the system is running with flow-compensated differential pressure control – DPT_1 , see figure 4.2.4.
- The differential pressure transmitter is placed close to the consumers and the system is running with differential pressure control – DPT_2 in fig. 4.2.4.

The advantage of the first solution is that the pump, the PI-controller, the speed control and the transmitter are placed close to one another, making the installation easy. This installation makes it possible to get the entire system as one single unit, see section 4.4. In order to get the system up and running, pump curve data have to be

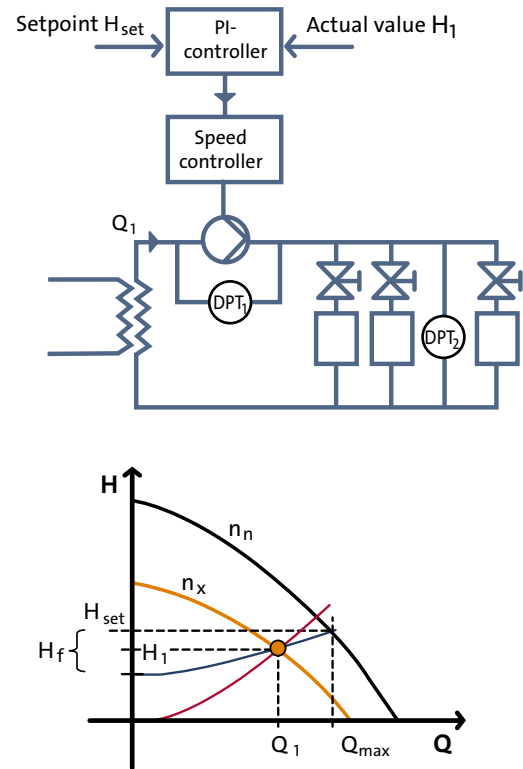


Fig. 4.2.4: Heating system with speed-controlled circulator pump delivering flow-compensated differential pressure to the system

stored in the controller. These data are used to calculate the flow and likewise to calculate how much the setpoint H_{set} has to be reduced at a given flow to ensure that the pump performance meets the required blue curve in figure 4.2.4.

The second solution with the transmitter placed in the installation requires more installation costs because the transmitter has to be installed at the installation site and the necessary cabling has to be carried out as well. The performance of this system is more or less similar to the first system. The transmitter measures the differential pressure at the consumer and compensates automatically for the increase in required pressure in order to overcome the increase in pressure losses in the supply pipes, etc.

Section 4.3

Advantages of speed control



A large number of pump applications do not require full pump performance 24 hours a day. Therefore, it is an advantage to be able to adjust the pump's performance in the system automatically. As we saw in section 4.1, the best possible way of adapting the performance of a centrifugal pump is by means of speed control of the pump. Speed control of pumps is normally made by a frequency converter unit.

On the following pages we will have a look at speed-controlled pumps in closed and open systems. But before we dig any further into the world of speed control, we will present the advantages that speed control provides and the benefits that speed-controlled pumps with frequency converter offer.

Reduced energy consumption

Speed-controlled pumps only use the amount of energy needed to solve a specific pump job. Compared to other control methods, frequency-controlled speed control offers the highest efficiency and thus the most efficient utilization of the energy, see section 4.1.

Low life cycle costs

As we will see in chapter 5, the energy consumption of a pump is a very important factor considering a pump's life cycle costs. Therefore, it is important to keep the operating costs of a pumping system at the lowest possible level. Efficient operation leads to lower energy consumption and thus to lower operating costs. Compared to fixed speed pumps, it is possible to reduce the energy consumption by up to 50% with a speed-controlled pump.

Protection of the environment

Energy efficient pumps pollute less and thus do not harm the environment.

Increased comfort

Speed control in different pumping systems provides increased comfort: In water supply systems, automatic pressure control and soft-start of pumps reduce water hammer and noise generated by too high pressure in the system. In circulating systems, speed-controlled pumps ensure that the differential pressure is kept at a level so that noise in the system is minimised.

Reduced system costs

Speed-controlled pumps can reduce the need for commissioning and control valves in the system. Therefore, the total system costs can be reduced.

Section 4.4

Advantages of pumps with integrated frequency converter

In many applications, pumps with integrated frequency converter is the optimum solution. The reason is that these pumps combine the benefits of a speed-controlled pump solution with the benefits gained from combining a pump, a frequency converter, a PI-controller and sometimes also a sensor/pressure transmitter in one single unit – see figure 4.4.1.

A pump with integrated frequency converter is not just a pump, but a system which is able to solve application problems or save energy in a variety of pump installations. As regards replacement, pumps with integrated frequency converters are ideal as they can be installed instead of fixed speed pumps at no extra installation cost. All that is required is a power supply connection and a fitting of the pump with integrated frequency converter in the pipe system, and then the pump is ready for operation. All the installer has to do is to adjust the required setpoint (pressure) after which the system is operational.

What follows is a brief description of the advantages that pumps with integrated frequency converter have to offer.

Easy to install

Pumps with integrated frequency converter are just as easy to install as fixed speed pumps. All you have to do is to connect the motor to the electrical power supply and the pump is in operation. The manufacturer has made all internal connections and adjustments.

Optimal energy savings

Because the pump, the motor and the frequency converter are designed for compatibility, operation of the pump system reduces power consumption.

One supplier

One supplier can provide pump, frequency converter and sensor which naturally facilitate the dimensioning, selection, ordering procedures, as well as maintenance and service procedures.

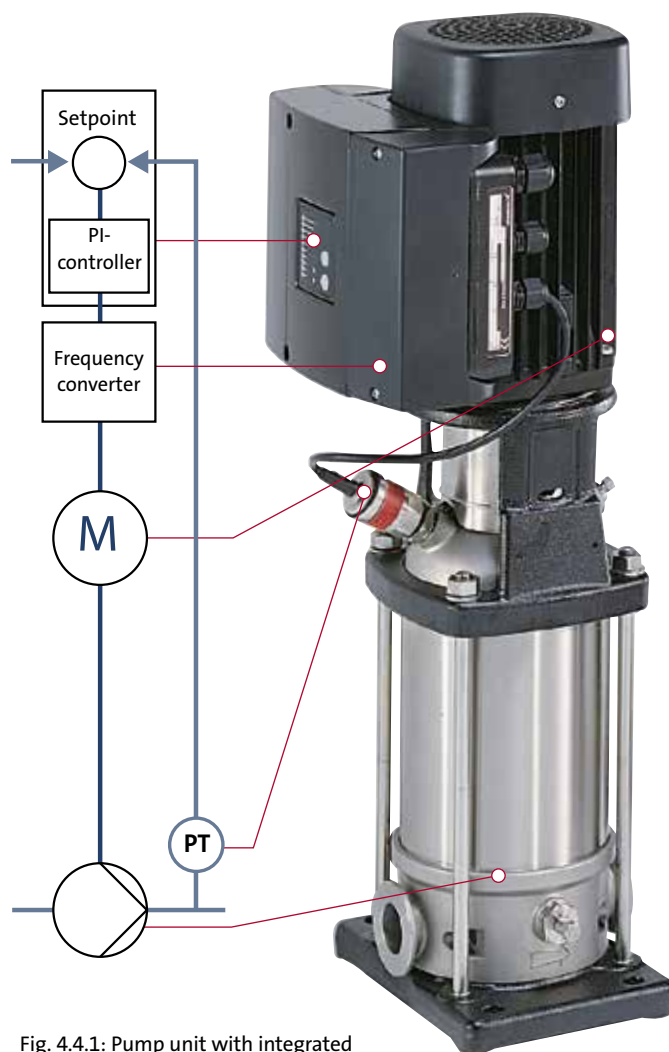


Fig. 4.4.1: Pump unit with integrated frequency converter and pressure transmitter

Wide performance range

Pumps with integrated frequency converter have a very broad performance range, which enables them to perform efficiently under widely varied conditions and to meet a wide range of requirements. Thus, fewer pumps can replace many fixed speed pump types with narrow performance capabilities.

4.4.1. Performance curves of speed-controlled pumps

Now, let us have a closer look at how you can read a speed-controlled pump's performance curve.

Figure 4.4.2 shows an example of the performance curves of a speed-controlled pump. The first curve shows the QH curve and the second curve shows the corresponding power consumption curve.

As you can tell, the performance curves are given for every 10% decrease in speed from 100% down to 50%. Likewise, the minimum curve represented by 25% of the maximum speed is also shown. As we have indicated in the diagram, you can point out a specific duty point QH and find out at which speed the duty point can be reached and what the power consumption P_1 is.

4.4.2 Speed-controlled pumps in different systems

Speed-controlled pumps are used in a wide range of systems. The change in pump performance and consequently the potential energy saving depend on the system in question.

As we discussed in chapter 3, the characteristic of a system is an indication of the required head a pump has to deliver in order to transport a certain quantity of liquid through the system. Figure 4.4.3 shows the performance curve and the system characteristic of a closed and an open system.

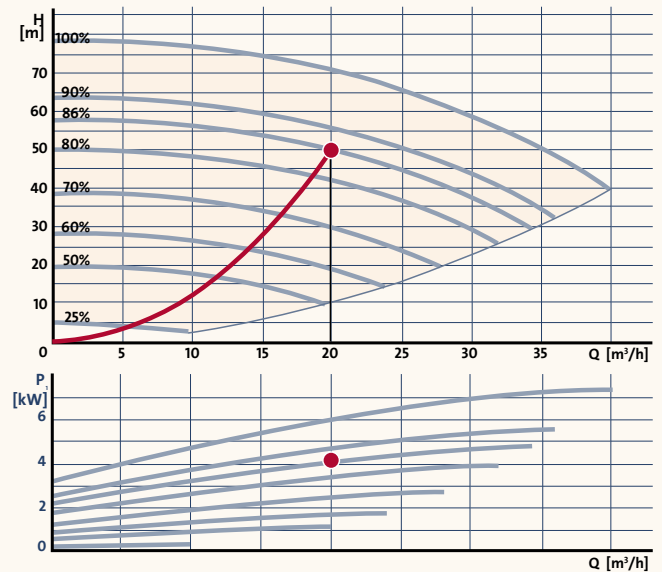


Fig 4.4.2: Performance curve for a speed-controlled pump

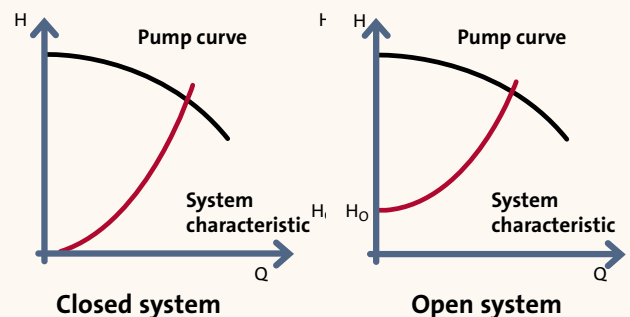


Fig 4.4.3: System characteristic point of a closed and an open system

Section 4.4

Advantages of pumps with integrated frequency converter

Speed-controlled pumps in closed systems

In closed systems, like heating and air-conditioning systems, the pump has only to overcome the friction losses in the pipes, valves, heat exchangers, etc. In this section, we will present an example with a speed-controlled pump in a closed system. The total friction loss by a full flow of $15 \text{ m}^3/\text{h}$ is 18 m, see figure 4.4.4.

The system characteristic starts in the point (0,0), the red line in figure 4.4.5. The control valves in the system always need a certain operating pressure, so therefore the pump cannot work according to the system characteristic. That is why some speed-controlled pumps offer the proportional pressure control function, which ensures that the pump will operate according to the orange line shown in the figure. As you can tell from the figure 4.4.5, the minimum performance is around 57% of the full speed. In a circulating system operation at the minimum curve (25% of the full speed) can be relevant in some situations, for example when we deal with night-time duty in heating systems.

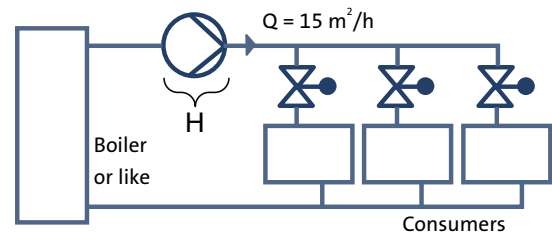


Fig. 4.4.4: Closed system

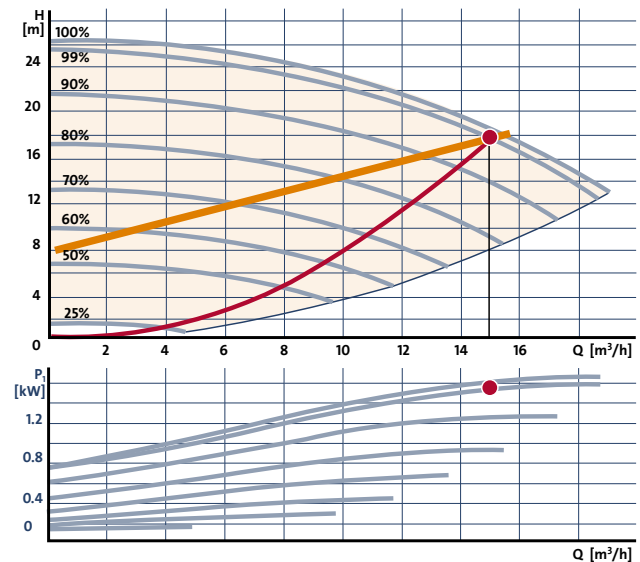


Fig. 4.4.5: A speed-controlled pump in a closed system

Speed-controlled pumps in open systems

The system characteristic as well as the operating range of the pump depend on the type of system in question. Figure 4.4.6 shows a pump in a pressure boosting / water supply system. The pump has to supply $Q = 6.5 \text{ m}^3/\text{h}$ to the tap, which is placed $h = 20 \text{ m}$ above the pump. The inlet pressure to the pump p_s is 1 bar, the pressure at the tap p_t has to be 2 bar and the total friction loss in the system by full flow p_f is 1.3 bar.

Figure 4.4.7 shows the QH curve of a pump, which is able to meet the requirements described before. You can calculate the required head at zero flow (H_o) by using the equation on your right.

If you need to calculate the maximum head at a flow (Q) of $6.5 \text{ m}^3/\text{h}$, this is the equation to use:

$$H_{\max} = H_o + \frac{P_f}{\rho \cdot g} = 30.2 + \frac{1.3 \cdot 10^5}{998 \cdot 9.81} = 43.5 \text{ m}$$

To cover this application from zero flow to maximum flow $Q = 6.5 \text{ m}^3/\text{h}$ the pump operates in a relative narrow speed band, that is from about 65% of the full speed and up to 99% of the full speed. In systems with less friction loss the variation in speed will be even smaller. If no friction loss, the minimum speed in the above case is about 79% speed.

As you can tell from the previous two examples, the possible variation in speed and consequently in power consumption is highest in closed systems. Therefore, the closed systems account for the highest energy saving potential.

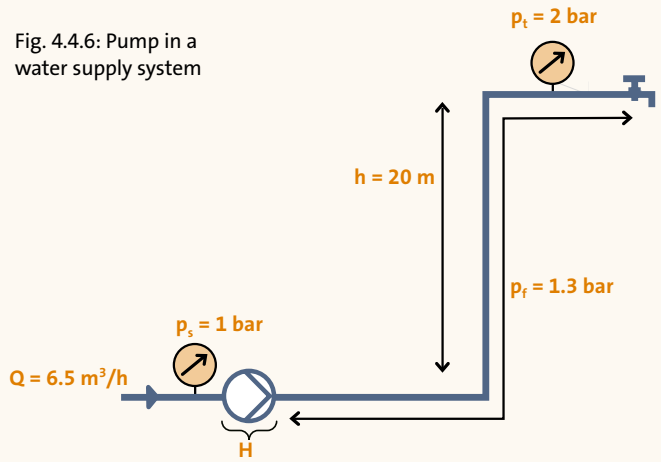


Fig. 4.4.6: Pump in a water supply system

- p_t - Pressure at tapping point
- p_s - Suction pressure
- p_f - Friction loss
- Q - Flow rate
- h - Static lift

$$H_o = h + \frac{p_t - p_s}{\rho \cdot g} = 20 + \frac{(2-1) \cdot 10^5}{998 \cdot 9.81} = 30.2 \text{ m}$$

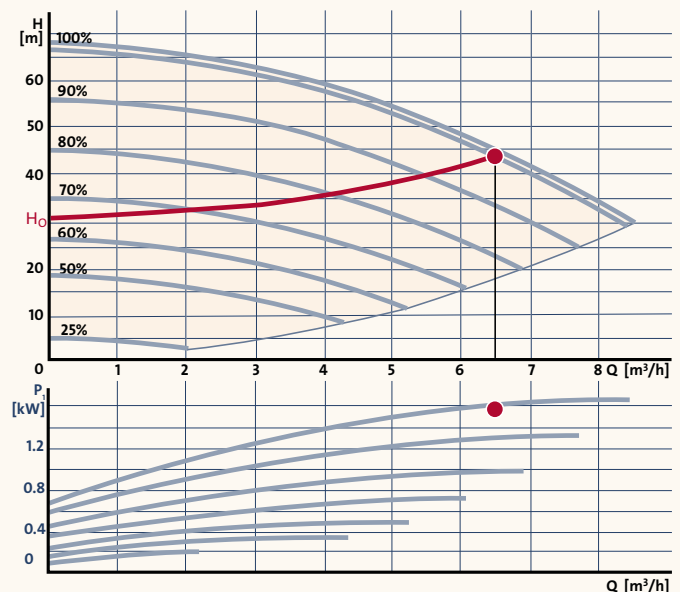


Fig. 4.4.7: A speed-controlled pump in an open system

Section 4.5

Frequency converter

As mentioned earlier, speed control of pumps involves a frequency converter. Therefore, it will be relevant to have a closer look at a frequency converter, how it operates and finally to discuss related precautions by using this device.

4.5.1 Basic function and characteristics

It is a well-known fact that the speed of an asynchronous motor depends primarily on the pole number of the motor and the frequency of the voltage supplied. The amplitude of the voltage supplied and the load on the motor shaft also influence the motor speed, however, not to the same degree. Consequently, changing the frequency of the supply voltage is an ideal method for asynchronous motor speed control. In order to ensure a correct motor magnetisation it is also necessary to change the amplitude of the voltage.

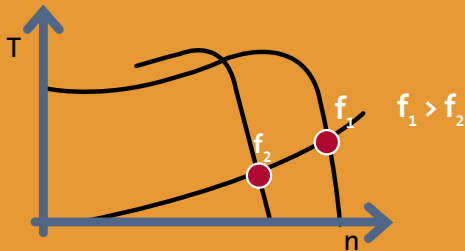


Fig. 4.5.1: Displacement of motor torque characteristic

A frequency/voltage control results in a displacement of the torque characteristic whereby the speed is changed. Figure 4.5.1 shows the motor torque characteristic (T) as a function of the speed (n) at two different frequencies/voltages. In the same diagram is also drawn the load characteristic of the pump. As it appears from the figure, the speed is changed by changing frequency/voltage of the motor.

The frequency converter changes frequency and voltage, so therefore we can conclude that the basic task of a frequency converter is to change the fixed supply voltage/frequency, e.g. 3x400 V / 50 Hz, into a variable voltage/frequency.

4.5.2. Components of the frequency converter

In principle, all frequency converters consist of the same functional blocks. The basic function is as mentioned previously, to convert the mains voltage supply into a new AC voltage with another frequency and amplitude. The frequency converter first of all rectifies the incoming mains voltage and then stores the energy in an intermediate circuit consisting of a capacitor. The DC voltage is then converted into a new AC voltage with another frequency and amplitude.

It does not matter if the frequency is 50 Hz or 60 Hz as the rectifier can handle both situations. Additionally, the incoming frequency will not influence the output frequency, as this is defined by the voltage/frequency pattern, which is defined in the inverter. Keeping the above-mentioned facts in mind, using a frequency converter in connection with asynchronous motors provides the following benefits:

- The system can be used in both 50 and 60 cycle-areas without any modifications
- The output frequency of the frequency converter is independent on the incoming frequency
- The frequency converter can supply output frequencies higher than mains supply frequency – makes oversynchronous operation possible.

As you can tell from figure 4.5.2, the frequency converter consists of three other components as well: An EMC filter, a control circuit and an inverter.

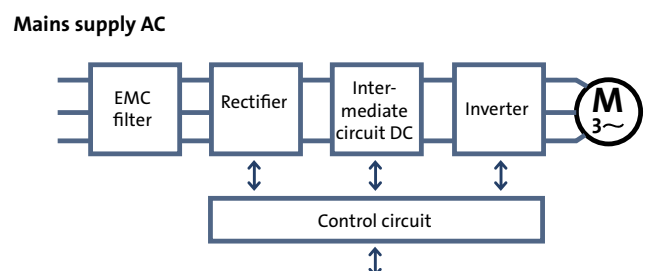


Fig. 4.5.2: Functional blocks of the frequency converter



The EMC filter

This block is not part of the primary function of the frequency converter and therefore, in principle, could be left out of the frequency converter. However, in order to meet the requirements of the EMC directive of the European Union or other local requirements, the filter is necessary.

The EMC filter ensures that the frequency converter does not send unacceptably high noise signal back to the mains thus disturbing other electronic equipment connected to the mains. At the same time, the filter ensures that noise signals in the mains generated by other equipment do not enter the electronic devices of the frequency converter causing damage or disturbances.

The control circuit

The control circuit block has two functions: It controls the frequency converter and at the same time, it takes care of the entire communication between the product and the surroundings.

The inverter

The output voltage from a frequency converter is not sinusoidal like the normal mains voltage is. The voltage supplied to the motor consists of a number of square-wave pulses, see figure 4.5.3. The mean value of these pulses forms a sinusoidal voltage of the desired frequency and amplitude. The switching frequency can be from a few kHz up to 20 kHz, depending on the brand. To avoid noise generation in the motor windings, a frequency converter with a switching frequency above the range of audibility (~16 kHz) is preferable.

This principle of inverter operation is called PWM (Pulse Width Modulation) control and it is the control principle which is most often used in frequency converters today. The motor current itself is almost sinusoidal. This is shown in figure 4.5.4 (a) indicating motor current (top) and motor voltage. In figure 4.5.4 (b) a section of the motor voltage is shown. This indicates how the pulse/pause ratio of the voltage changes.

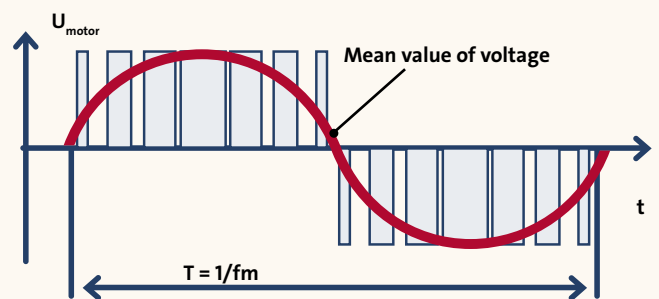


Fig 4.5.3: AC voltage with variable frequency (f_m) and variable voltage (U_{motor})

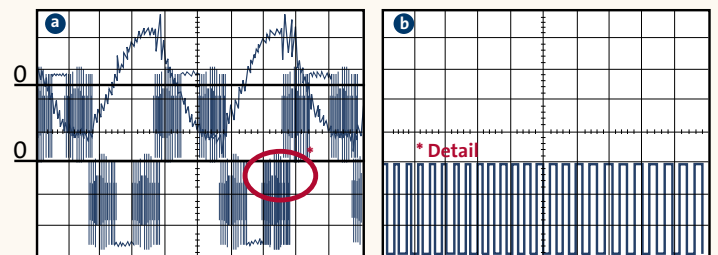


Fig 4.5.4: a) Motor current (top) and motor voltage at PWM (Pulse Width Modulation) control. b) Section of motor voltage

Section 4.5

Frequency converter

4.5.3 Special conditions regarding frequency converters

By installing and using frequency converters or pumps with integrated frequency converters, there are some conditions, which the installer and user have to be aware of. A frequency converter will behave differently at the mains supply side than a standard asynchronous motor. This is described in detail below.

Non-sinusoidal power input, three-phase supplied frequency converters

A frequency converter designed as the one described above will not receive sinusoidal current from the mains. Among other things, this influences the dimensioning of mains supply cable, mains switch, etc. Figure 4.5.5 shows how mains current and voltage appear for a:

- a) three-phase, two-pole standard asynchronous motor
- b) three-phase, two-pole standard asynchronous motor with frequency converter.

In both cases the motor supplies 3 kW to the shaft.

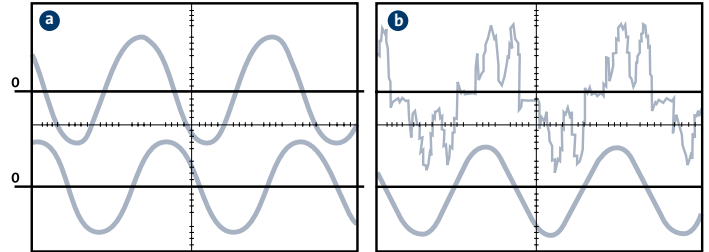


Fig 4.5.5 a): Three-phase, two-pole standard asynchronous motor

Fig 4.5.5 b): Three-phase, two-pole standard asynchronous motor with frequency converter

	Standard motor	Motor with frequency converter
Mains voltage	400 V	400 V
Mains current RMS	6.4 A	6.36 A
Mains current, peak	9.1 A	13.8 A
Power input, P1	3.68 kW	3.69 kW
cos φ, power factor (PF)	cosφ = 0.83	PF = 0.86

Fig. 4.5.6: Comparison of current of a standard motor and a frequency converter

A comparison of the current in the two cases shows the following differences, see figure 4.5.6:

- The current for the system with frequency converter is not sinusoidal
- The peak current is much higher (approx. 52% higher) for the frequency converter solution

This is due to the design of the frequency converter connecting the mains to a rectifier followed by a capacitor. The charging of the capacitor happens during short time periods in which the rectified voltage is higher than the voltage in the capacitor at that moment.

As mentioned above, the non-sinusoidal current results in other conditions at the mains supply side of the motor. For a standard motor without a frequency converter the relation between voltage (U), current (I) and power (P) is shown in the box on your right hand side. The same formula cannot be used for the calculation of the power input in connection with motors with frequency converters.

$$P = \sqrt{3} \cdot U \cdot I \cdot \cos\varphi$$

- U** - the voltage between two phases
- I** - the phase current
Both effective values (RMS values), apply for U and I
- cosφ** - the phase displacement between current and voltage

Calculation example

U = 400 V, I = 6.4 A, cosφ = 0.83

The result is a power input of P = 3.68 kW



In fact, in this case there is no safe way of calculating the power input based on simple current and voltage measurements as these are not sinusoidal. Instead, the power must be calculated by means of instruments and on the basis of instantaneous measurements of current and voltage.

If the power (P) is known as well as the RMS value of current and voltage, the so-called power factor (PF) can be calculated by the formula on your right hand side.

$$PF = \frac{P}{\sqrt{3} \cdot U \cdot I}$$

Unlike what is the case when current and voltage are sinusoidal, the power factor has no direct connection with the way in which current and voltage are displaced in time.

When measuring the input current in connection with installation and service of a system with frequency converter it is necessary to use an instrument that is capable of measuring “non-sinusoidal” currents. In general, current measuring instruments for frequency converters must be of a type measuring “True RMS”.

Frequency converters and earth-leakage circuit breakers (ELCB)

Earth-leakage circuit breakers are used increasingly as extra protection in electrical installations. If a frequency converter is to be connected to such an installation it must be ensured that the ELCB installed is of a type which will surely brake - also if failure occurs on the DC side of the frequency converter. In order to be sure that the ELCB always will brake in case of earth-leakage current the ELCB's to be used in connection with frequency converter must be labelled with the signs shown in figures 4.5.7 and 4.5.8

Both types of earth-leakage circuit breaker are available in the market today.



Fig 4.5.7: Labelling of the ELCB for single-phase frequency converters

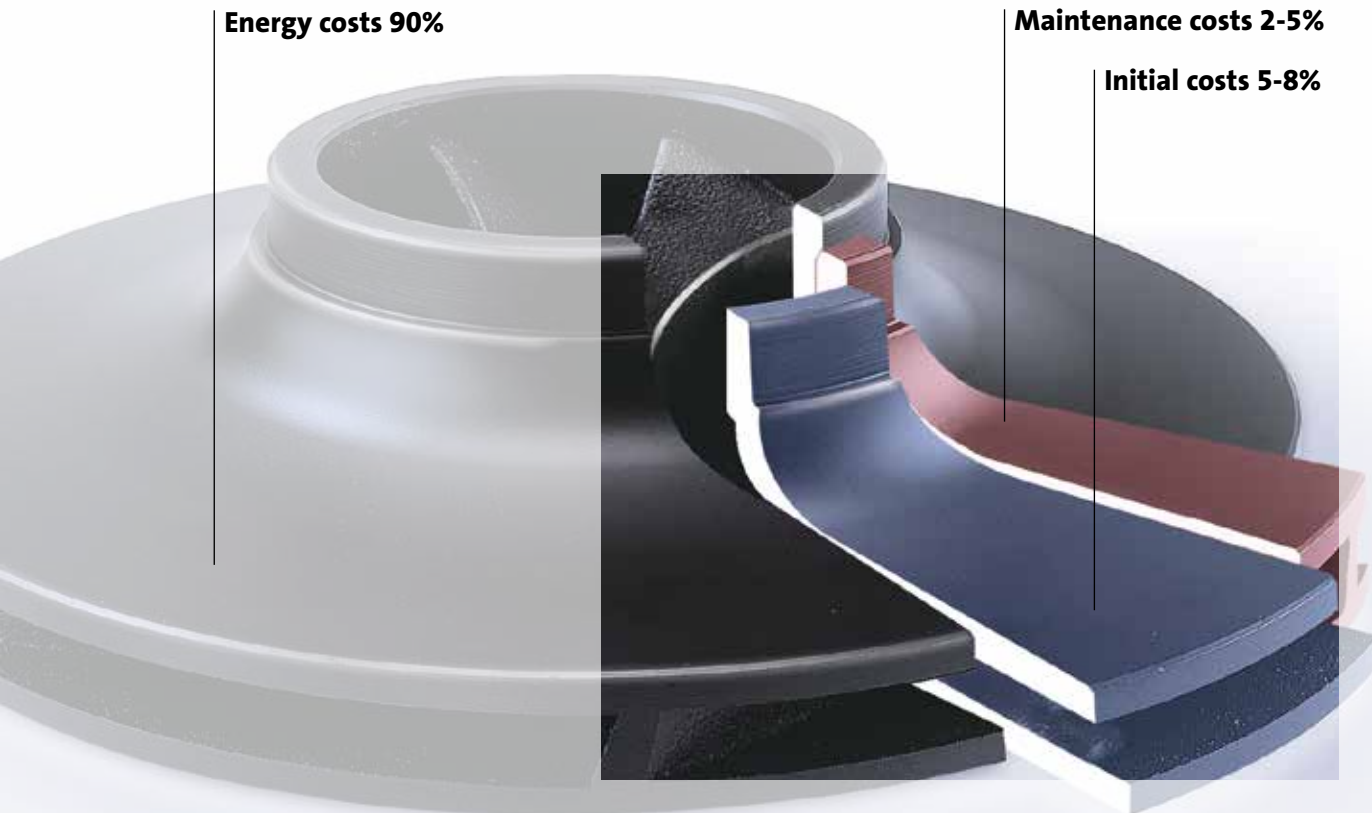


Fig 4.5.8: Labelling of the ELCB for three-phase frequency converters

Section 5.1: Life cycle costs equation

- 5.1.1 Initial costs, purchase price (C_{ic})
- 5.1.2 Installation and commissioning costs (C_{in})
- 5.1.3 Energy costs (C_e)
- 5.1.4 Operating costs (C_o)
- 5.1.5 Environmental costs (C_{env})
- 5.1.6 Maintenance and repair costs (C_m)
- 5.1.7 Downtime costs, loss of production costs (C_s)
- 5.1.8 Decommissioning and disposal costs (C_d)

Section 5.2: Life cycle costs calculation – an example



Section 5.1

Life cycle costs equation

In this section we will focus on the elements that make up a pump's life cycle costs (LCC) in order to understand what LCC is, which factors to consider when we calculate it and how to calculate it. Finally, we will illustrate the notion life cycle costs by an example. But before we dig any further into life cycle costs, we need to understand what the notion covers.

The life cycle costs of a pump are an expression of how much it costs to purchase, install, operate, maintain and dispose of a pump during its lifetime.

The Hydraulic Institute, Europump and the US Department of Energy have elaborated a tool called the Pump Life cycle costs (LCC), see figure 5.1.1. The tool is designed to help companies minimise the waste and maximise the energy efficiency in different systems including pumping systems. Life cycle cost calculations are a decision-making tool that can be used in connection with design of new installations or repair of existing installations.

The life cycle costs (LCC) consist of the following elements:

C_{ic}	Initial costs, purchase price
C_{in}	Installation and commissioning costs
C_e	Energy costs
C_o	Operating costs (labour costs)
C_{emv}	Environmental costs
C_m	Maintenance and repair costs
C_s	Downtime costs (loss of production)
C_d	Decommissioning/disposal costs

In the following paragraphs, each of these elements is described. As it appears from figure 5.1.2, the energy costs, initial costs and maintenance costs are the most important.

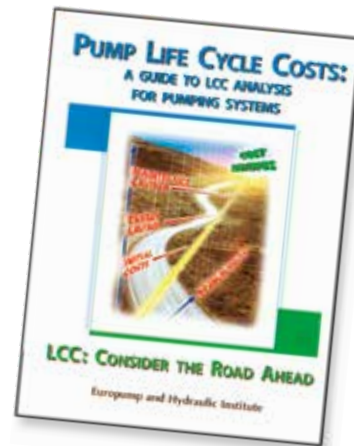


Fig. 5.1.1: A guide to life cycle costs analysis for pumping systems

Typical life cycle costs

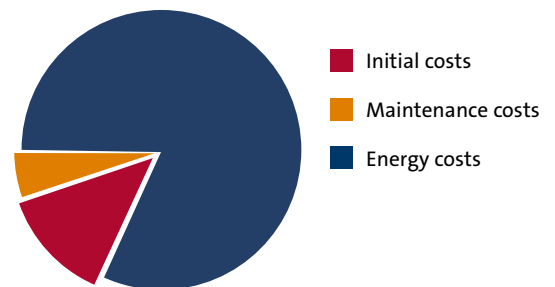


Fig. 5.1.2: Typical life cycle costs of a circulating system in the industry

LCC is calculated by the following formula:

$$LCC = C_{ic} + C_{in} + C_e + C_o + C_m + C_s + C_{emv} + C_d$$



5.1.1 Initial costs, purchase price (C_{ic})

The initial costs (C_{ic}) of a pump system include all equipment and accessories necessary to operate the system, e.g. pumps, frequency converters, control panels and transmitters, see figure 5.1.3.

Often, there is a trade-off between the initial costs and the energy and maintenance costs. Thus, in many cases expensive components have a longer lifetime or a lower energy consumption than inexpensive components have.

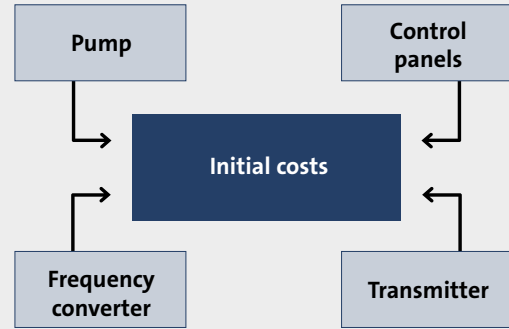


Fig. 5.1.3: Equipment that makes up a pumping system

5.1.2 Installation and commissioning costs (C_{in})

The installation and commissioning costs include the following costs:

- Installation of the pumps
- Foundation
- Connection of electrical wiring and instrumentation
- Installation, connection and set-up of transmitters, frequency converters, etc
- Commissioning evaluation at start-up

As was the case for initial costs, it is important to check the trade-off options. In connection with pumps with integrated frequency converter, many of the components are already integrated in the product. Therefore, this kind of pump is often subject to higher initial costs and lower installation and commissioning costs.

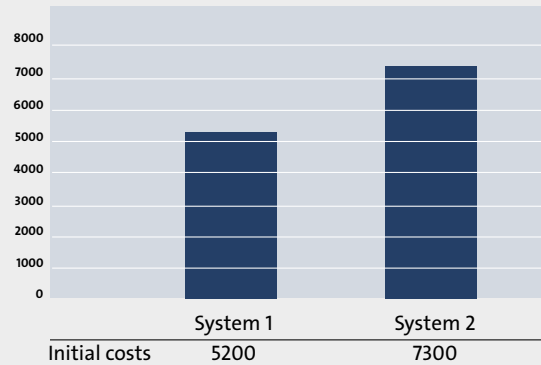


Fig. 5.1.4: Initial costs of a constant speed pump system (system 1) and a controlled pump system (system 2)

Section 5.1

Life cycle costs equation

5.1.3 Energy costs (C_e)

In the majority of cases, energy consumption is the largest cost in the life cycle costs of a pump system, where pumps often run more than 2000 hours per year. Actually, around 20% of the world's electrical energy consumption is used for pump systems, see figure 5.1.5. What follows is a list of some of the factors influencing the energy consumption of a pump system:

- Load profile
- Pump efficiency (calculation of the duty point), see figure 5.1.6
- Motor efficiency (the motor efficiency at partial load can vary significantly between high efficiency motors and normal efficiency motors)
- Pump sizing (often margins and round ups tend to suggest oversized pumps)
- Other system components, such as pipes and valves
- Use of speed-controlled solutions. By using speed-controlled pumps in the industry, it is possible to reduce the energy consumption by up to 50%

5.1.4 Operating costs (C_o)

Operating costs cover labour costs related to the operation of a pumping system. In most cases the labour costs related to the pumps are modest. Today, different types of surveillance equipment make it possible to connect the pump system to a computer network, making the operating costs low.

5.1.5 Environmental costs (C_{env})

The environmental costs cover the disposal of parts and contamination from the pumped liquid. The environmental factor's contribution to the life cycle costs of a pumping system in the industry is modest.

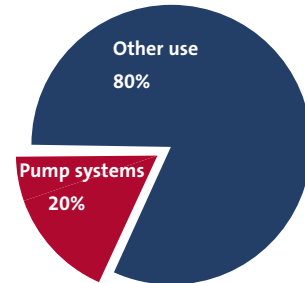


Fig. 5.1.5: Energy consumption worldwide

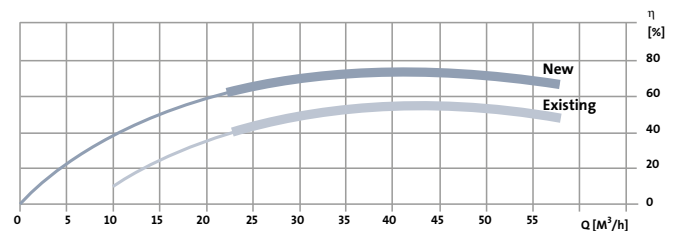


Fig. 5.1.6: Comparison of the efficiency of a new and an existing pump



5.1.6 Maintenance and repair costs (C_m)

Maintenance and repair costs cover as the name implies all costs related to maintenance and repair of the pump system, for example: Labour costs, spare parts, transportation and cleaning.

The best way to obtain the optimum working life of a pump and to prevent breakdowns is to carry out preventive maintenance.

5.1.7 Downtime costs, loss of production costs (C_s)

Downtime costs are extremely important when it comes to pump systems used in production processes. The reason is simple; it costs a lot of money to stop a production, even for a shorter period of time. Even though one pump is enough for the required pump performance, it is always a good idea to install a standby pump that can take over and make sure that the production continues even if an unexpected failure in the pump system should occur, see figure 5.1.7.

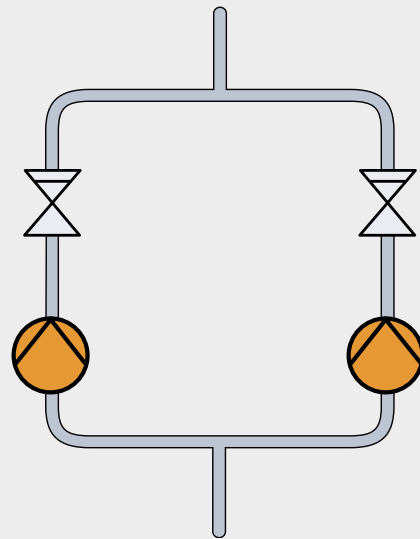


Fig. 5.1.7: Standby pump makes sure that production continues in case of pump break-down

5.1.8 Decommissioning and disposal costs (C_d)

Depending on the pump manufacturer, decommissioning and disposal costs of a pump system are subject to minor variations. Therefore, this cost is seldom taken into consideration.

Calculating the life cycle costs

The life cycle costs of a pump system are made up of the summation of all the above-mentioned components over the system's lifetime. Typically, the lifetime is said to be in the range of 10 to 20 years. In the pump business, the life cycle costs are normally calculated by a more simplified formula with fewer elements to consider. This formula is shown on your right.

$$LCC = C_{ic} + C_e + C_m$$

Section 5.2

Life cycle costs calculation – an example

Let us have a look at an example using the simplified formula mentioned previously: An industry needs a new water supply pump and two solutions are taken into consideration:

- A fixed speed multistage centrifugal pump
- A variable speed multistage centrifugal pump

Calculations show that compared to the fixed speed pump, the variable speed pump consumes 40% less energy. However, the initial costs (C_{ic}) of the variable speed pump is twice as high as that of the fixed speed pump.

Life cycle costs calculations will help determine which pump to install in the system. The application has the following characteristics:

- 12 operating hours per day
- 220 operating hours per year
- Lifetime of 10 years (calculation period)

Based on these data, it is possible to calculate the life cycle costs of the two solutions.

Even though the initial costs of a variable speed pump are twice as high compared to a fixed speed pump, the total costs of the first-mentioned solution are 25% lower than the fixed speed pump solution after 10 years.

Besides the lower life cycle costs, the variable speed pump provides, as discussed in chapter 4, some operational benefits, e.g. constant pressure in the system.

The payback time of the variable speed pump solution is a bit longer because the pump is more expensive. As you can tell from figure 5.1.9, the payback time is around 2½ years, and in general industrial applications, this is considered to be a good investment.

Pump types		Fixed speed	Variable speed
Average power consumption	kW	18.76	11.31
Operating hours per day	hours	12	12
Working days per year	days	220	220
Calculation period	years	10	10
Total energy consumption	kWh	495,264	298,584
Electrical power price	Euro/kWh	0.07	0.07
Pump price	Euro	3,602	7,204
Maintenance costs	Euro	1,417	1,417
Energy costs	Euro	33,284	20,066
Total costs	Euro	38,303	28,688

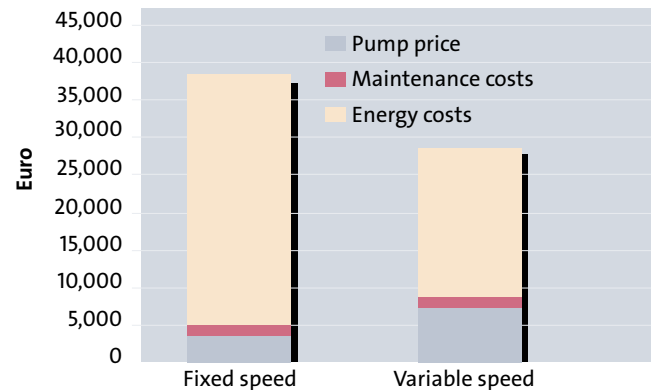


Fig. 5.1.8: Life cycle costs of a fixed and a variable speed pump

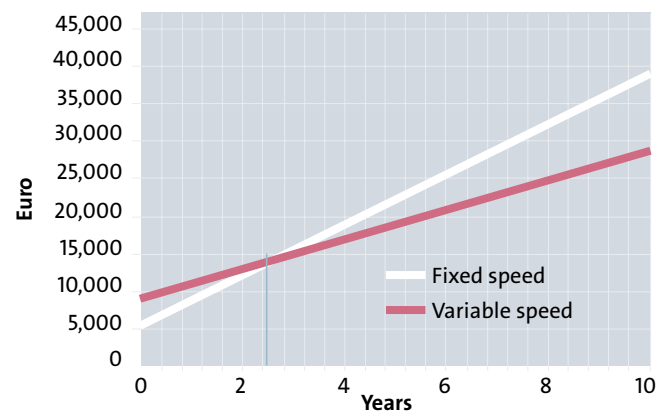


Fig. 5.1.9: Payback time for a fixed and a variable speed pump

Appendix

- A) Notations and units
- B) Unit conversion tables
- C) SI-prefixes and Greek alphabet
- D) Vapour pressure and density of water at different temperatures
- E) Orifice
- F) Change in static pressure due to change in pipe diameter
- G) Nozzles
- H) Nomogram for head losses in bends, valves, etc
- I) Pipe loss nomogram for clean water 20°C
- J) Periodical system
- K) Pump standards
- L) Viscosity for different liquids as a function of liquid temperature

Notations and units

The table below provides an overview of the most commonly used notations and units in connection with pumps and pump systems.

Notation	Unit			Remarks
	SI unit	Other commonly used unit(s)		
H	m		Head	
Q	m ³ /s	m ³ /h, l/s	Volume flow	
Q _m	kg/s	kg/h	Mass flow	
P	pa=N/m ²	hPa, kPa, bar	Pressure	1 bar =10 ⁵ Pa
Δp	Pa	kPa, bar	Differential pressure	
NPSH	m		Net Positive Suction Head	
ρ	kg/m ³	kg/dm ³	Density	
ν	m ² /s	cSt (centiStoke), mm ² /s	Kinematic viscosity	1 cSt =10 ⁻⁶ m ² /s
μ	Pa·s	Poise	Dynamic viscosity	1 poise=0.1 Pa·s
t	°C	°F	Temperature	
T	K		Absolute temperature	
d	m	mm	Diameter	
D	m	mm	Diameter	
g	m/s ²		Acceleration of gravity	g = 9.81 m/s ²
v	m/s		Velocity	
η		%	Efficiency	
n	s ⁻¹	min ⁻¹ , RPM	Rotational speed	
t	s	min, h	Time	
P	W	kW	Power	
U	V		Voltage	
I	A		Current	
f	Hz		Frequency	
cosφ			Cosine to phase angle between U and I	
PF			Power factor	

Unit conversion tables

The conversion tables for pressure and flow show the most commonly used units in connection with pumping systems

Pressure

	Pascal (=Newton per square metre)	bar	kibpond per square metre	meter Water Column	Technical atmosphere	Physical atmosphere	pound per square inch	
	Pa, (N/m ²)	bar	kp/m ²	mWC	at kp/m ²	atm	psi (lb/in ²)	
1 Pa	1	10 ⁻⁵	0.1020	1.020 · 10 ⁻⁴	1.020 · 10 ⁻⁵	9.869 · 10 ⁻⁴	1.450 · 10 ⁻⁴	1 Pa
1 bar	10 ⁵	1	10197	10.20	1.020	0.9869	14.50	1 bar
1 kp/m²	9.8067	9.807 · 10 ⁻⁵	1	10 ⁻³	10 ⁻⁴	0.9678 · 10 ⁻⁴	1.422 · 10 ⁻³	1 kp/m²
1 m WC	9806.7	0.09807	10 ³	1	0.1	0.09678	1.422	1 m WC
1 at	98067	0.9807	10 ⁴	10	1	0.9678	14.22	1 at
1 atm	101325	1.013	10333	10.33	1.033	1	14.70	1 atm
1 psi	6895	0.06895	703.1	0.7031	0.07031	0.06804	1	1 psi

Flow (volume)

	Cubic metre per second	Cubic metre per hour	Litre per second	Gallon (UK) per minute	Gallon (US) per minute	
	m ³ /s	m ³ /h	l/s	UK GPM	UK GPM	
1 m³/s	1	3600	1000	1320	15651	1 m³/s
1 m³/h	2.778 · 10 ⁻⁴	1	0.2778	3.667	4.403	1 m³/h
1 l/s	10 ⁻³	3.6	1	13.2	15.85	1 l/s
1 UK GPM	7.577 · 10 ⁻⁵	0.02728	0.07577	1	1.201	1 UK GPM
1 US GPM	6.309 · 10 ⁻⁵	0.02271	0.06309	0.8327	1	1 US GPM

Temperature

The formulas listed below show how to convert the most commonly used units for temperature.

From degrees Celsius to Kelvin: $T [K] = 273.15 + t [^{\circ}C]$

From degrees Celsius to degrees Fahrenheit: $t [^{\circ}F] = 32 + 1.8 t [^{\circ}C]$

Degrees Celsius	Kelvin	Degrees Fahrenheit
°C	K	°F
0	273.15	32
100	373.15	212
-17.8	255.35	0

$\Delta t, \Delta t$	Δt	Δt	Δt
	°C	K	°F
1 °C =	1	1	32
1 K =	1	1	5/9
1 °F =	9/5	9/5	1

SI-prefixes and Greek alphabet

Factor		Prefix	Symbol
10^9	1,000,000,000	giga	G
10^6	1,000,000	mega	M
10^3	1,000	kilo	k
10^2	100	hekto	h
10	10	deka	da
10^{-1}	0.1	deci	d
10^{-2}	0.01	centi	c
10^{-3}	0.001	milli	m
10^{-6}	0.000.001	mikro	μ
10^{-9}	0.000.000.001	nano	n

Greek alphabet		
Alfa	A	α
Beta	B	β
Gamma	Γ	γ
Delta	Δ	δ
Epsilon	E	ϵ
Zeta	Z	ζ
Eta	H	η
Theta	Θ	θ
Jota	I	ι
Kappa	K	κ
Lambda	Λ	λ
My	M	μ
Ny	N	ν
Ksi	$\text{K}\Sigma$	$\kappa\sigma$
Omikron	O	\omicron
Pi	Π	π
Rho	P	ρ
Sigma	Σ	σ
Tau	T	τ
Ypsilon	Y	υ
Fi	Φ	ϕ
Khi	X	χ
Psi	Ψ	ψ
Omega	Ω	ω

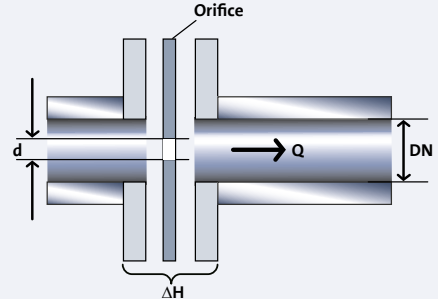
Vapour pressure and density of water at different temperatures

This table shows the vapour pressure p [bar] and the density ρ [kg/m³] of water at different temperatures t [°C]. Likewise, the table shows the corresponding absolute temperature T [K].

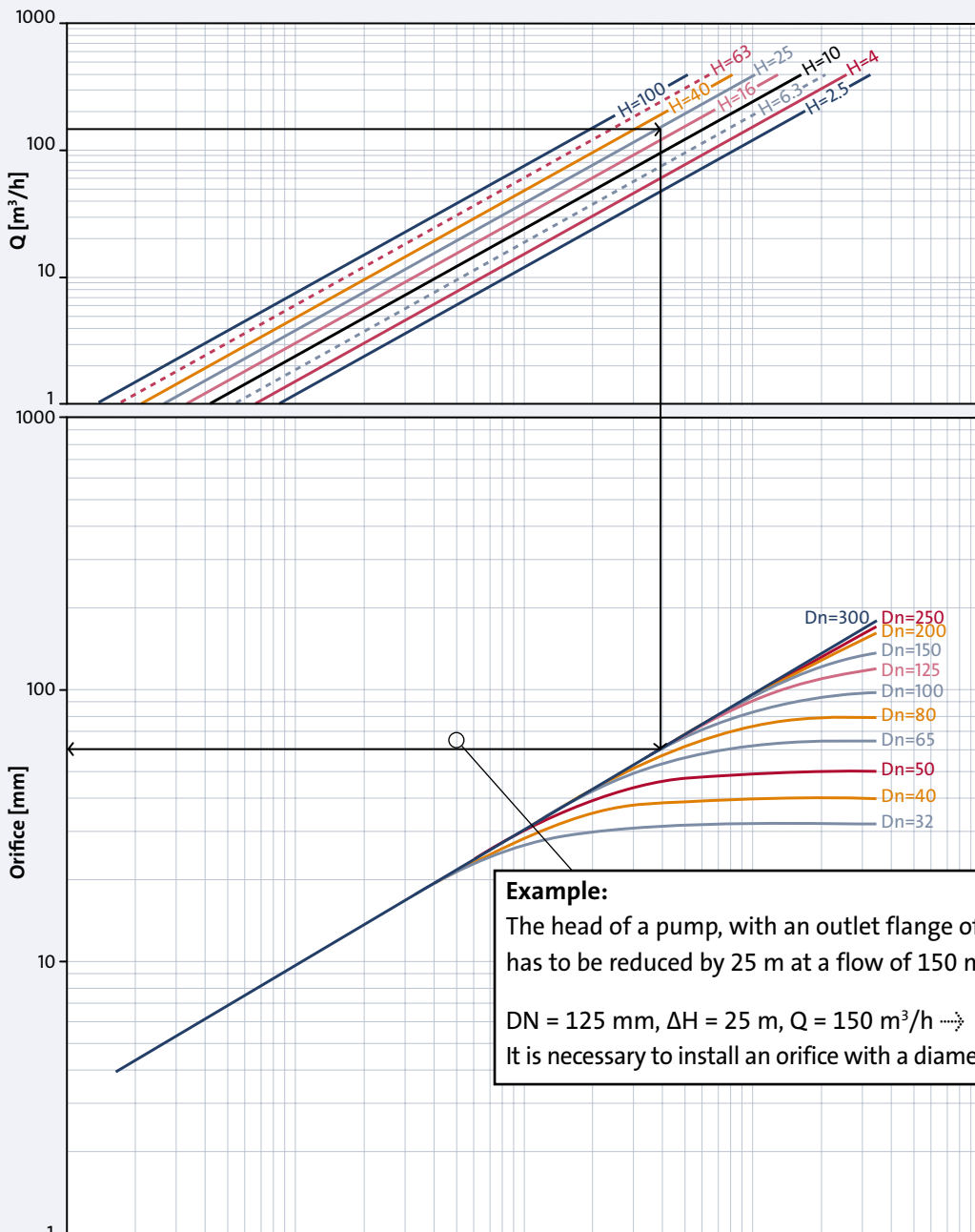
Vapour pressure p and density ρ of water at different temperatures											
t [°C]	T [K]	P [bar]	ρ [kg/m ³]	t [°C]	T [K]	P [bar]	ρ [kg/m ³]	t [°C]	T [K]	P [bar]	ρ [kg/m ³]
0	273.15	0.00611	999.8					138	411.15	3.414	927.6
1	274.15	0.00657	999.9	61	334.15	0.2086	982.6	140	413.15	3.614	925.8
2	275.15	0.00706	999.9	62	335.15	0.2184	982.1	145	418.15	4.155	921.4
3	276.15	0.00758	999.9	63	336.15	0.2286	981.6	150	423.15	4.760	916.8
4	277.15	0.00813	1000.0	64	337.15	0.2391	981.1				
5	278.15	0.00872	1000.0	65	338.15	0.2501	980.5	155	428.15	5.433	912.1
6	279.15	0.00935	1000.0	66	339.15	0.2615	979.9	160	433.15	6.181	907.3
7	280.15	0.01001	999.9	67	340.15	0.2733	979.3	165	438.15	7.008	902.4
8	281.15	0.01072	999.9	68	341.15	0.2856	978.8	170	443.15	7.920	897.3
9	282.15	0.01147	999.8	69	342.15	0.2984	978.2	175	448.15	8.924	892.1
10	283.15	0.01227	999.7	70	343.15	0.3116	977.7				
								180	453.15	10.027	886.9
11	284.15	0.01312	999.7	71	344.15	0.3253	977.0	185	458.15	11.233	881.5
12	285.15	0.01401	999.6	72	345.15	0.3396	976.5	190	463.15	12.551	876.0
13	286.15	0.01497	999.4	73	346.15	0.3543	976.0	195	468.15	13.987	870.4
14	287.15	0.01597	999.3	74	347.15	0.3696	975.3	200	473.15	15.50	864.7
15	288.15	0.01704	999.2	75	348.15	0.3855	974.8				
16	289.15	0.01817	999.0	76	349.15	0.4019	974.1	205	478.15	17.243	858.8
17	290.15	0.01936	998.8	77	350.15	0.4189	973.5	210	483.15	19.077	852.8
18	291.15	0.02062	998.7	78	351.15	0.4365	972.9	215	488.15	21.060	846.7
19	292.15	0.02196	998.5	79	352.15	0.4547	972.3	220	493.15	23.198	840.3
20	293.15	0.02337	998.3	80	353.15	0.4736	971.6	225	498.15	25.501	833.9
21	294.15	0.02485	998.1	81	354.15	0.4931	971.0	230	503.15	27.976	827.3
22	295.15	0.02642	997.8	82	355.15	0.5133	970.4	235	508.15	30.632	820.5
23	296.15	0.02808	997.6	83	356.15	0.5342	969.7	240	513.15	33.478	813.6
24	297.15	0.02982	997.4	84	357.15	0.5557	969.1	245	518.15	36.523	806.5
25	298.15	0.03166	997.1	85	358.15	0.5780	968.4	250	523.15	39.776	799.2
26	299.15	0.03360	996.8	86	359.15	0.6011	967.8	255	528.15	43.246	791.6
27	300.15	0.03564	996.6	87	360.15	0.6249	967.1				
28	301.15	0.03778	996.3	88	361.15	0.6495	966.5	260	533.15	46.943	783.9
29	302.15	0.04004	996.0	89	362.15	0.6749	965.8	265	538.15	50.877	775.9
30	303.15	0.04241	995.7	90	363.15	0.7011	965.2	270	543.15	55.058	767.8
								275	548.15	59.496	759.3
31	304.15	0.04491	995.4	91	364.15	0.7281	964.4	280	553.15	64.202	750.5
32	305.15	0.04753	995.1	92	365.15	0.7561	963.8				
33	306.15	0.05029	994.7	93	366.15	0.7849	963.0	285	558.15	69.186	741.5
34	307.15	0.05318	994.4	94	367.15	0.8146	962.4	290	563.15	74.461	732.1
35	308.15	0.05622	994.0	95	368.15	0.8453	961.6	295	568.15	80.037	722.3
36	309.15	0.05940	993.7	96	369.15	0.8769	961.0	300	573.15	85.927	712.2
37	310.15	0.06274	993.3	97	370.15	0.9094	960.2	305	578.15	92.144	701.7
38	311.15	0.06624	993.0	98	371.15	0.9430	959.6	310	583.15	98.700	690.6
39	312.15	0.06991	992.7	99	372.15	0.9776	958.6				
40	313.15	0.07375	992.3	100	373.15	1.0133	958.1	315	588.15	105.61	679.1
								320	593.15	112.89	666.9
41	314.15	0.07777	991.9	102	375.15	1.0878	956.7	325	598.15	120.56	654.1
42	315.15	0.08198	991.5	104	377.15	1.1668	955.2	330	603.15	128.63	640.4
43	316.15	0.08639	991.1	106	379.15	1.2504	953.7	340	613.15	146.05	610.2
44	317.15	0.09100	990.7	108	381.15	1.3390	952.2				
45	318.15	0.09582	990.2	110	383.15	1.4327	950.7	350	623.15	165.35	574.3
46	319.15	0.10086	989.8					360	633.15	186.75	527.5
47	320.15	0.10612	989.4	112	385.15	1.5316	949.1				
48	321.15	0.11162	988.9	114	387.15	1.6362	947.6	370	643.15	210.54	451.8
49	322.15	0.11736	988.4	116	389.15	1.7465	946.0	374.15	647.30	221.2	315.4
50	323.15	0.12335	988.0	118	391.15	1.8628	944.5				
				120	393.15	1.9854	942.9				
51	324.15	0.12961	987.6								
52	325.15	0.13613	987.1	122	395.15	2.1145	941.2				
53	326.15	0.14293	986.6	124	397.15	2.2504	939.6				
54	327.15	0.15002	986.2	126	399.15	2.3933	937.9				
55	328.15	0.15741	985.7	128	401.15	2.5435	936.2				
56	329.15	0.16511	985.2	130	403.15	2.7013	934.6				
57	330.15	0.17313	984.6								
58	331.15	0.18147	984.2	132	405.15	2.8670	932.8				
59	332.15	0.19016	983.7	134	407.15	3.041	931.1				
60	333.15	0.19920	983.2	136	409.15	3.223	929.4				

Orifice

As discussed in chapter 3, the duty point of a pump is adjusted by adding a resistance in connected series with the pump. In practice, this is normally done by placing an orifice in the outlet flange of the pump.



The following graph provides the orifice diameter d [mm] based on the pipe/port dimension DN [mm], the flow Q [m^3/h] and the required head loss ΔH [m].



Example:
 The head of a pump, with an outlet flange of 125 mm, has to be reduced by 25 m at a flow of 150 m³/h.
 DN = 125 mm, $\Delta H = 25$ m, $Q = 150$ m³/h \rightarrow
 It is necessary to install an orifice with a diameter of 59 mm.

Change in static pressure due to change in pipe diameter

As described in chapter 2.2, a change in pipe dimension results in a change in liquid velocity and consequently, a change in dynamic and static pressure.

When head has to be determined (see page 86), the difference in the two port dimensions requires a correction of the measured head.

ΔH has to be added to the measured head of the pump:

$$\Delta H = \frac{v_2^2 - v_1^2}{2 \cdot g} = \frac{8 \cdot Q^2}{g \cdot \pi^2} \cdot \left[\frac{1}{D_2^4} - \frac{1}{D_1^4} \right]$$

where :

v_1 is the liquid velocity in the inlet port in [m/s]

v_2 is the liquid velocity in the outlet port in [m/s]

Q is the flow rate in [m³/s]

g is the acceleration of gravity in [m/s²]

D_1 is the diameter of the inlet port in [m]

D_2 is the diameter of the outlet port in [m]

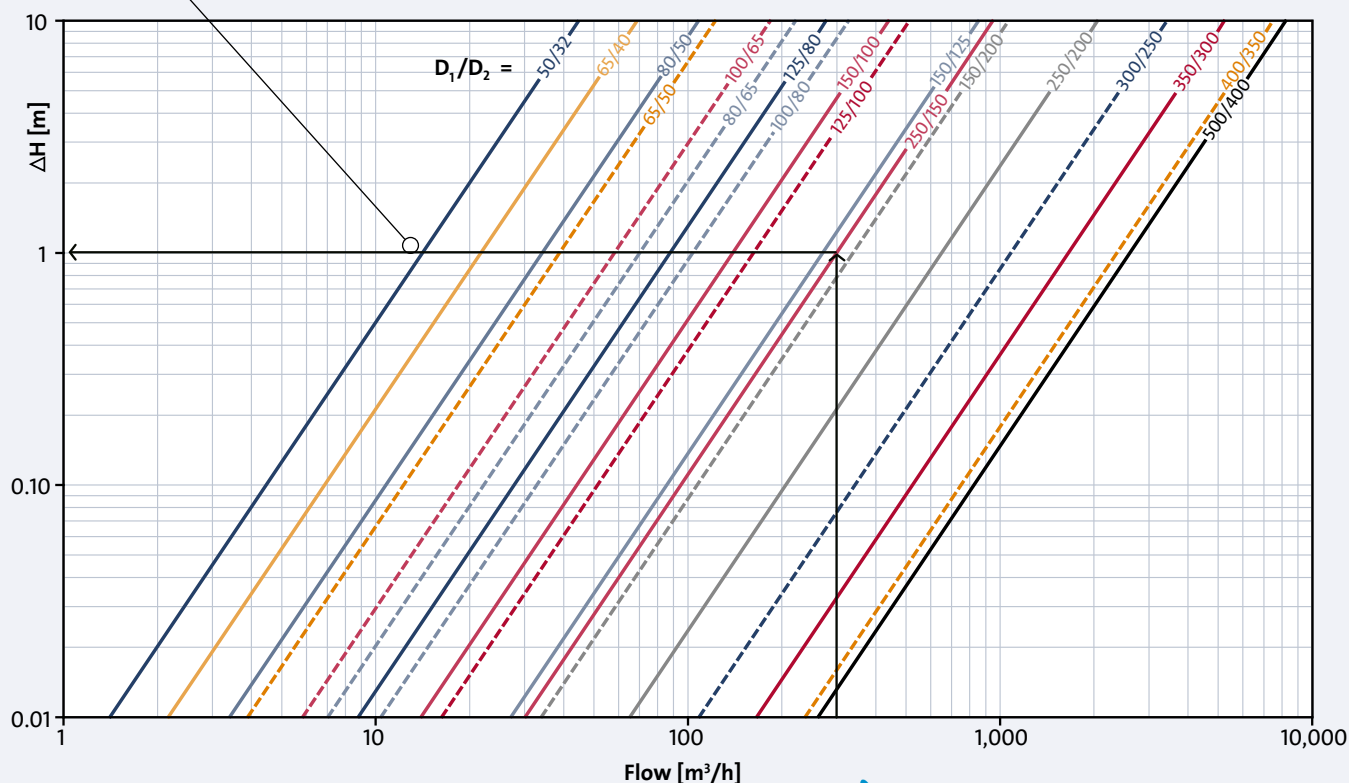
The graph shows the ΔH value for typical sets of port dimensions D_1/D_2 as a function of the flow Q . In this case, flow Q is measured in [m³/h] and ΔH is measured in [m].

Example:

A pump with an inlet port of 250 mm and an outlet port of 150 mm is pumping 300 m³/h. How much does the difference in port dimension affect the measured head?

$D_1 = 250 \text{ mm}$ $D_2 = 150 \text{ mm}$ $Q = 300 \text{ m}^3/\text{h}$

As it appears from the graph, the difference in head is $\Delta H = 1 \text{ m}$.

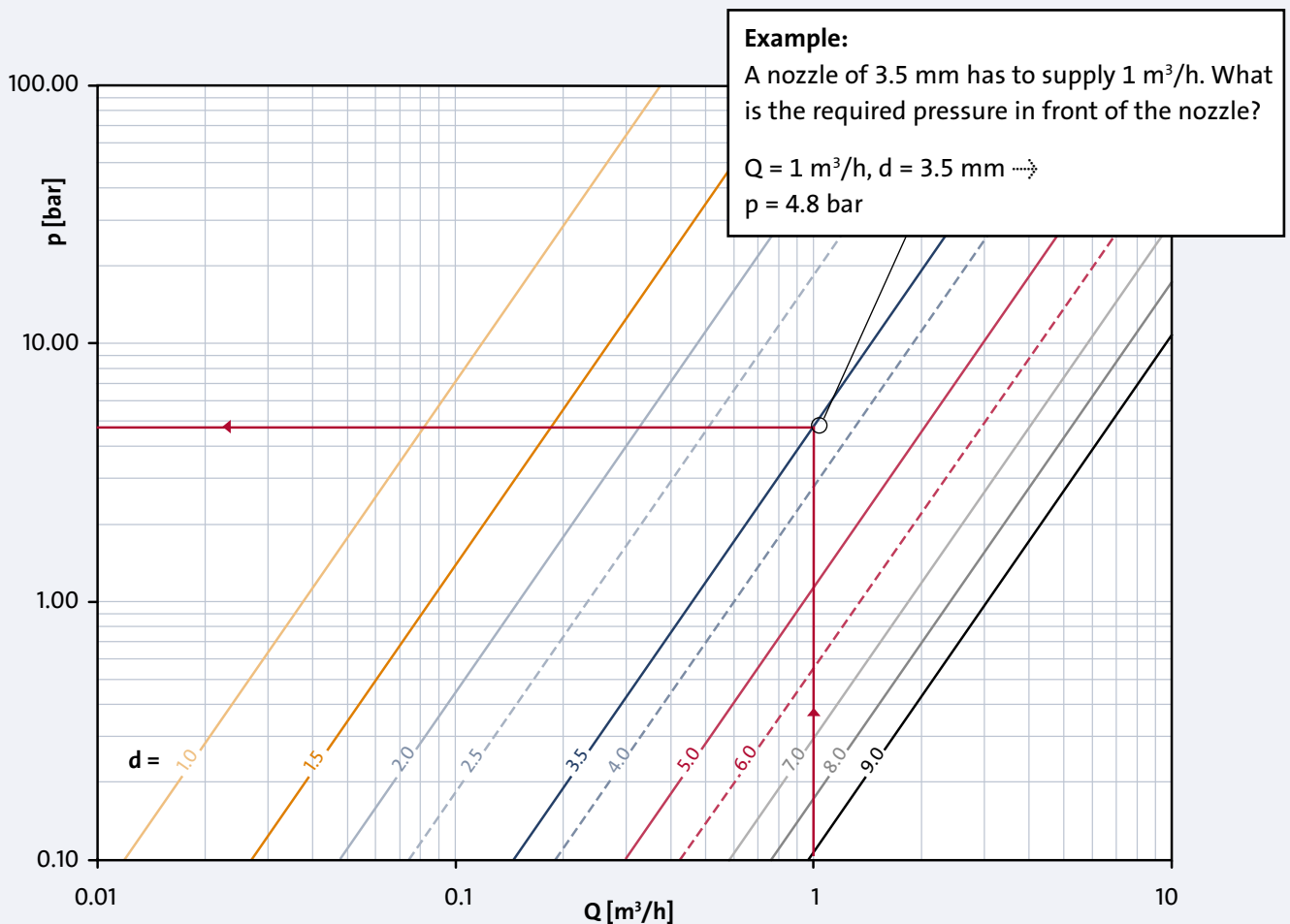
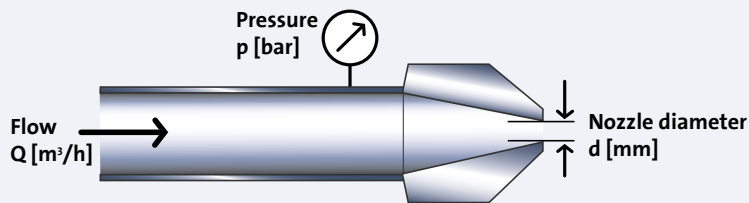


Nozzles

The relation between the nozzle diameter d [mm], the needed flow Q [m³/h] and the required pressure before the nozzle p [bar] is found by the nomogram below. We assume that the nozzle has a quadratic behaviour:

$$\frac{Q_1}{Q_2} = \left(\frac{p_1}{p_2} \right)^n$$

where $n = 0.5$. Some nozzles have a lower n value (check with the supplier).

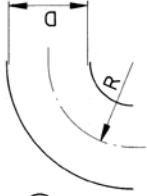


Nomogram for head losses in bends, valves, etc.

Guide values for head losses in bends, valves, etc.

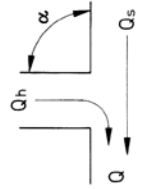
- Pipe bend 90°, R/D = 1,5
- Discharge loss
- Swing check valve
- Ball check valve
- Gate valve

- 0.3
- 1.0 (pipe without expansion)
- 1...2
- 0.7...1.2
- 0.2

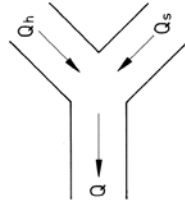


• T-piece

Q _h /Q	α = 90°		α = 45°	
	ζ _h	ζ _s	ζ _h	ζ _s
0.0	-1.00	0.04	-0.90	0.04
0.2	-0.40	0.17	-0.38	0.17
0.4	0.08	0.30	0.00	0.19
0.6	0.47	0.41	0.22	0.09
0.8	0.72	0.51	0.37	-0.17
1.0	0.91	0.60	0.37	-0.54

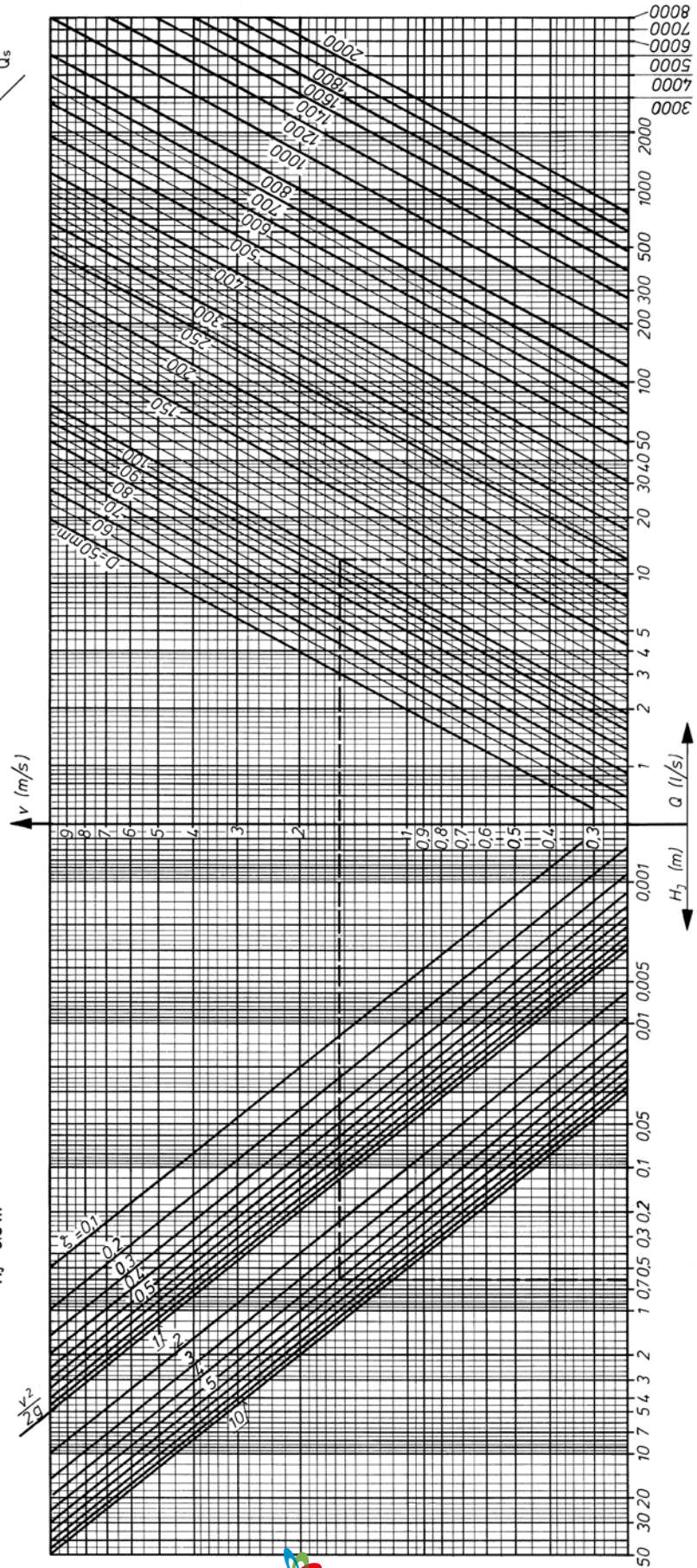


Q _h /Q	ζ _h		ζ _s	
	0.0	0.5	0.3	0.6
0.0	0.0	0.0	0.6	-
0.5	0.5	0.3	0.3	0.3
1.0	1.0	0.6	0.6	-



Q = Flow, l/s
 D = Pipe inner diameter, mm
 v = Flow velocity, m/s
 ζ = Loss coefficient
 H_J = Head losses, m

Example
 Q = 12 l/s
 D = 100 mm
 v = 1.55 m/s
 Σζ = 5
 H_J = 0.6 m



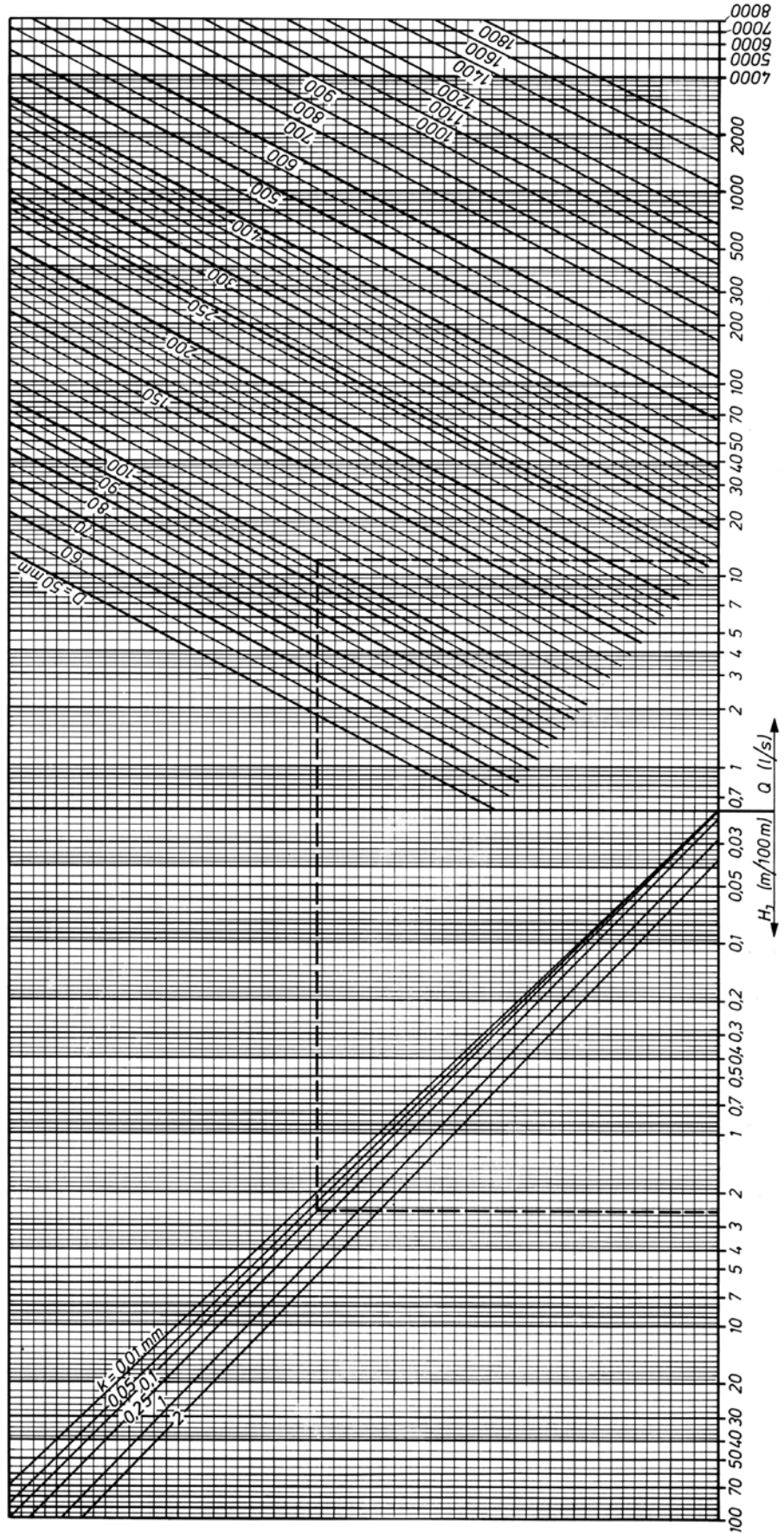
Pipe loss nomogram for clean water 20°C

Example
 Q = 12 l/s
 D = 100 mm
 k = 0.1 mm
 H₃ = 2.5 m/100 m

Q = Flow, l/s
 D = Pipe inner diameter, mm
 k = Surface roughness, mm
 H₃ = Pipe losses, m/100 m

Guide values for surface roughness (k) for pipes

pipe material	new pipe k (mm)	old pipe k (mm)
plastic	0.01	0.25
	0.05	1.0
drawn steel	0.1	1.0
welded steel	0.05	0.25
drawn stainless steel	0.1	0.25
welded stainless steel	0.25	1.0
cast iron	0.15	1.0
galvanized steel	0.15	1.0



Periodical system

1 H Hydrogen																	2 He Helium
3 Li Lithium	4 Be Beryllium											5 B Boron	6 C Carbon	7 N Nitrogen	8 O Oxygen	9 F Fluorine	10 Ne Neon
11 Na Sodium	12 Mg Magnesium											13 Al Aluminium	14 Si Silicon	15 P Phosphorus	16 S Sulphur	17 Cl Chlorine	18 Ar Argon
19 K Potassium	20 Ca Calcium	21 Sc Scandium	22 Ti Titanium	23 V Vanadium	24 Cr Chromium	25 Mn Manganese	26 Fe Iron	27 Co Cobalt	28 Ni Nickel	29 Cu Copper	30 Zn Zinc	31 Ga Gallium	32 Ge Germanium	33 As Arsenic	34 Se Selenium	35 Br Bromine	36 Kr Krypton
37 Rb Rubidium	38 Sr Strontium	39 Y Yttrium	40 Zr Zirconium	41 Nb Niobium	42 Mo Molybdenum	43 Tc Technetium	44 Ru Ruthenium	45 Rh Rhodium	46 Pd Palladium	47 Ag Silver	48 Cd Cadmium	49 In Indium	50 Sn Tin	51 Sb Antimony	52 Te Tellurium	53 I Iodine	54 Xe Xenon
55 Cs Caesium	56 Ba Barium	57 La Lutetium	72 Hf Hafnium	73 Ta Tantalum	74 W Tungsten	75 Re Rhenium	76 Os Osmium	77 Ir Iridium	78 Pt Platinum	79 Au Gold	80 Hg Mercury	81 Tl Thallium	82 Pb Lead	83 Bi Bismuth	84 Po Polonium	85 At Astatine	86 Rn Radon
87 Fr Francium	88 Ra Radium	89 Ac Actinium	104 Rf Rutherfordium	105 Db Dubnium	106 Sg Seaborgium	107 Bh Bohrium	108 Hs Hassium	109 Mt Meitnerium	110 Ds Darmstadtium	111 Rg Roentgenium	112 Uub Ununbium	113 Uut Ununtrium	114 UUq Ununquadium				
58 Ce Cerium	59 Pr Praseodymium	60 Nd Neodymium	61 Pm Promethium	62 Sm Samarium	63 Eu Europium	64 Gd Gadolinium	65 Tb Terbium	66 Dy Dysprosium	67 Ho Holmium	68 Er Erbium	69 Tm Thulium	70 Yb Ytterbium	71 Lu Lutetium				
90 Th Thorium	91 Pa Protactinium	92 U Uranium	93 Np Neptunium	94 Pu Plutonium	95 Am Americium	96 Cm Curium	97 Bk Berkelium	98 Cf Californium	99 Es Einsteinium	100 Fm Fermium	101 Md Mendelevium	102 No Nobelium	103 Lr Lawrencium				

Pump standards

Pump standards:

EN 733	End-suction centrifugal pumps, rating with 10 bar with bearing bracket
EN 22858	End-suction centrifugal pumps (rating 16 bar) - Designation, nominal duty point and dimensions

Pump-related standards:

ISO 3661	End-suction centrifugal pumps - Base plate and installation dimensions
EN 12756	Mechanical seals - Principal dimensions, designation and material codes
EN 1092	Flanges and their joints - Circular flanges for pipes, valves, fittings and accessories, PN-designated
ISO 7005	Metallic flanges
DIN 24296	Pumps, and pump units for liquids: Spare parts

Specifications, etc:

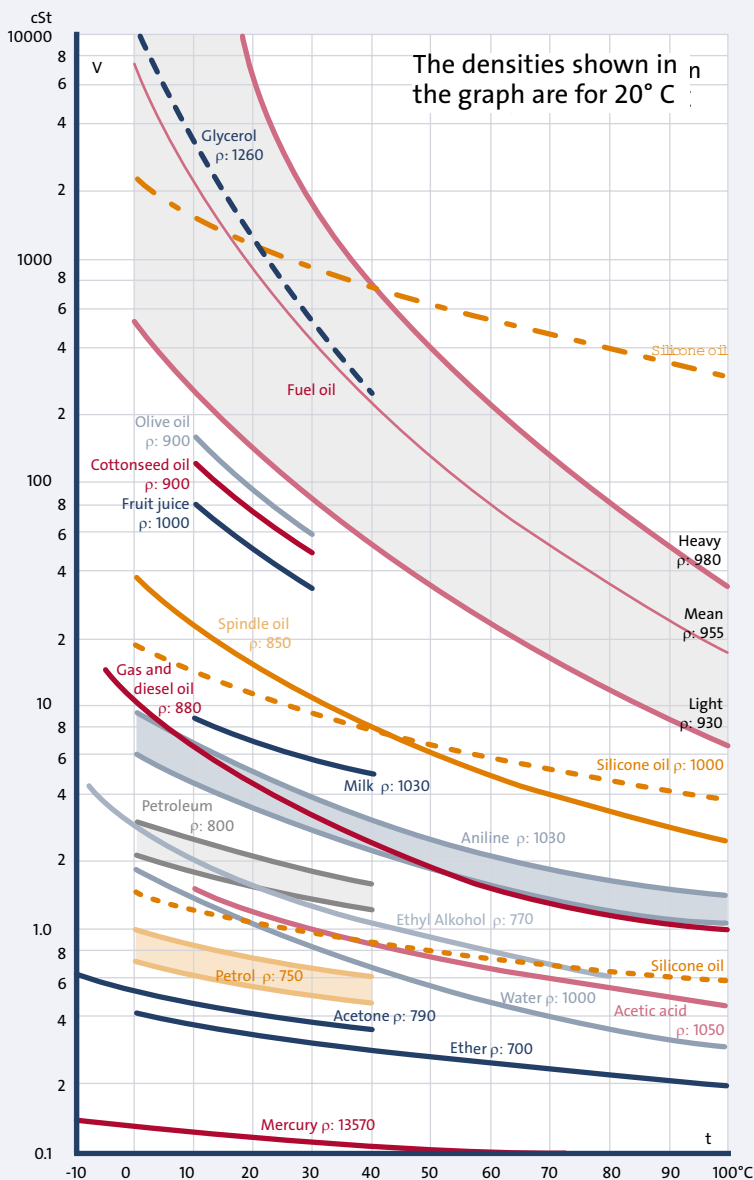
ISO 9905	Technical specifications for centrifugal pumps - Class 1
ISO 5199	Technical specifications for centrifugal pumps - Class 2
ISO 9908	Technical specifications for centrifugal pumps - Class 3
ISO 9906	Rotodynamic pumps - Hydraulic performance tests - Grades 1 and 2
EN 10204	Metallic products - Types of inspection documents
ISO/FDIS 10816	Mechanical vibration - Evaluation of machine vibration by measurements on non-rotating parts

Motor standards:

EN 60034/IEC 34	Rotating electrical machines
-----------------	------------------------------

Viscosity of typical liquids as a function of liquid temperature

The graph shows the viscosity of different liquids at different temperatures. As it appears from the graph, the viscosity decreases when the temperature increases.

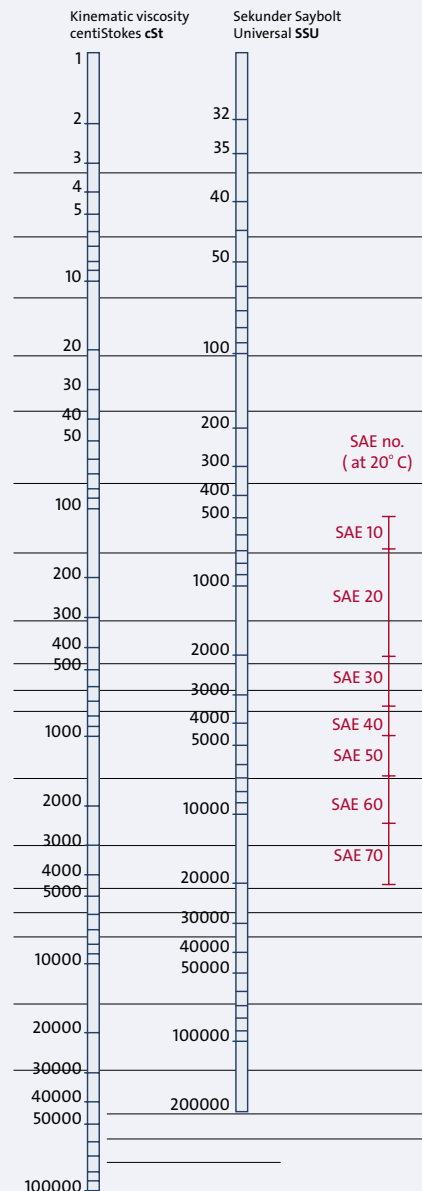


Viscosity

Kinematic viscosity is measured in centiStoke [cSt] ($1 \text{ cSt} = 10^{-6} \text{ m}^2/\text{s}$). The unit [SSU] Saybolt Universal is also used in connection with kinematic viscosity. The graph below shows the relation between kinematic viscosity in [cSt] and viscosity in [SSU]. The SAE-number is also indicated in the graph.

For kinematic viscosity above 60 cSt, the Saybolt Universal viscosity is calculated by the following formula:

$$[\text{SSU}] = 4.62 \cdot [\text{cSt}]$$



Ethylene glycol

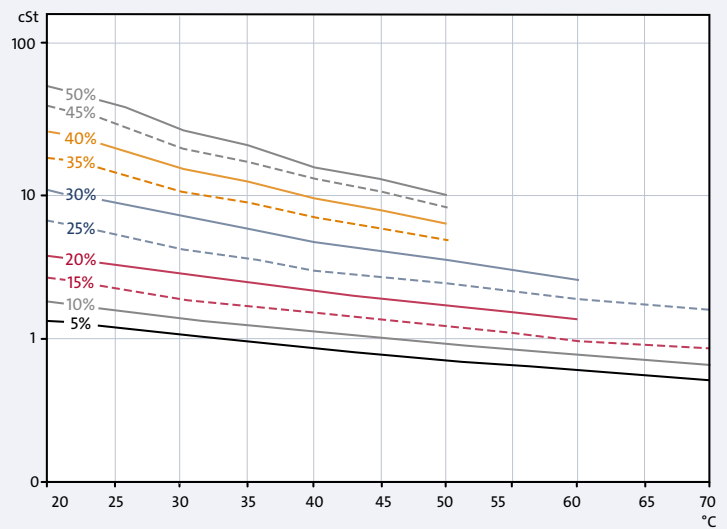
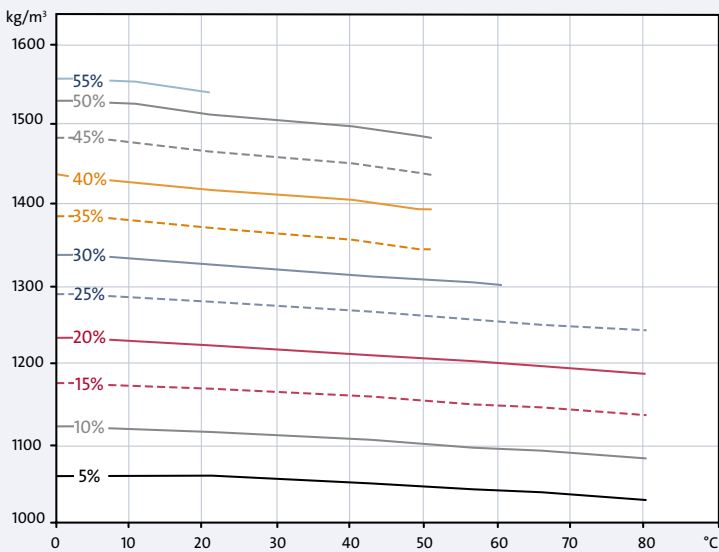
Concentration wt.%	10%		15%		20%		25%		30%		35%		40%		45%		50%		55%		60%		
	ρ [kg/m ³]	ν [cSt]	ρ [kg/m ³]	ν [cSt]	ρ [kg/m ³]	ν [cSt]	ρ [kg/m ³]	ν [cSt]	ρ [kg/m ³]	ν [cSt]	ρ [kg/m ³]	ν [cSt]	ρ [kg/m ³]	ν [cSt]	ρ [kg/m ³]	ν [cSt]	ρ [kg/m ³]	ν [cSt]	ρ [kg/m ³]	ν [cSt]	ρ [kg/m ³]	ν [cSt]	
Temperature																							
-50																						1107	259.7
-45																						1106	173.7
-40																			1098	101.2	1105	118.6	
-35																	1089	57.3	1097	68.9	1104	82.7	
-30															1081	32.3	1089	40.0	1096	48.1	1103	58.8	
-25															1080	23.5	1088	28.7	1095	34.4	1102	42.6	
-20													1072	14.1	1079	17.4	1086	21.1	1094	25.2	1101	31.5	
-15								1055	7.2	1063	8.8	1070	10.9	1078	13.2	1085	15.8	1092	18.8	1099	23.6		
-10							1046	4.9	1054	5.8	1062	7.0	1069	8.5	1077	10.2	1084	12.1	1091	14.3	1098	18.0	
-5			1028	2.9	1036	3.4	1045	4.0	1053	4.7	1060	5.7	1068	6.8	1075	8.1	1082	9.4	1089	11.1	1096	14.0	
0	1018	2.0	1027	2.5	1035	2.9	1043	3.3	1051	3.9	1059	4.7	1066	5.5	1074	6.5	1081	7.5	1088	8.8	1094	11.0	
5	1017	1.7	1026	2.1	1034	2.4	1042	2.8	1050	3.3	1057	3.9	1065	4.5	1072	5.3	1079	6.1	1086	7.1	1092	8.8	
10	1016	1.5	1024	1.8	1032	2.1	1041	2.4	1048	2.8	1056	3.2	1063	3.8	1070	4.4	1077	5.0	1084	5.8	1090	7.1	
15	1014	1.3	1023	1.6	1031	1.8	1039	2.1	1047	2.4	1054	2.8	1061	3.2	1068	3.7	1075	4.2	1082	4.8	1088	5.9	
20	1013	1.1	1021	1.4	1029	1.6	1037	1.8	1045	2.0	1052	2.4	1059	2.7	1066	3.1	1073	3.5	1079	4.0	1086	4.9	
25	1011	1.0	1019	1.2	1027	1.4	1035	1.6	1043	1.8	1050	2.1	1057	2.4	1064	2.7	1071	3.0	1077	3.4	1083	4.1	
30	1009	0.9	1018	1.1	1026	1.2	1033	1.4	1041	1.6	1048	1.8	1055	2.1	1062	2.3	1068	2.6	1075	3.0	1081	3.5	
35	1008	0.8	1016	1.0	1024	1.1	1031	1.2	1039	1.4	1046	1.6	1053	1.8	1059	2.1	1066	2.3	1072	2.6	1078	3.0	
40	1006	0.7	1014	0.9	1021	1.0	1029	1.1	1036	1.2	1043	1.4	1050	1.6	1057	1.8	1063	2.0	1069	2.3	1076	2.6	
45	1003	0.7	1011	0.8	1019	0.9	1027	1.0	1034	1.1	1041	1.3	1048	1.4	1054	1.6	1060	1.8	1067	2.0	1073	2.2	
50	1001	0.6	1009	0.7	1017	0.8	1024	0.9	1031	1.0	1038	1.1	1045	1.3	1051	1.5	1058	1.6	1064	1.8	1070	2.0	
55	999	0.6	1007	0.7	1014	0.7	1022	0.8	1029	0.9	1036	1.0	1042	1.2	1048	1.3	1055	1.5	1061	1.6	1066	1.7	
60	996	0.5	1004	0.6	1012	0.7	1019	0.7	1026	0.8	1033	0.9	1039	1.1	1045	1.2	1052	1.3	1058	1.4	1063	1.5	
65	994	0.5	1001	0.6	1009	0.6	1016	0.7	1023	0.8	1030	0.9	1036	1.0	1042	1.1	1048	1.2	1054	1.3	1060	1.4	
70	991	0.5	998	0.5	1006	0.6	1013	0.6	1020	0.7	1027	0.8	1033	0.9	1039	1.0	1045	1.1	1051	1.2	1056	1.2	
75	988	0.4	996	0.5	1003	0.5	1010	0.6	1017	0.6	1023	0.7	1030	0.8	1036	0.9	1042	1.0	1047	1.1	1053	1.1	
80	985	0.4	992	0.5	1000	0.5	1007	0.5	1014	0.6	1020	0.7	1026	0.8	1032	0.8	1038	0.9	1044	1.0	1049	1.0	
85	982	0.4	989	0.4	997	0.5	1003	0.5	1010	0.5	1017	0.6	1023	0.7	1029	0.8	1034	0.8	1040	0.9	1045	0.9	
90	979	0.3	986	0.4	993	0.4	1000	0.5	1007	0.5	1013	0.6	1019	0.6	1025	0.7	1031	0.8	1036	0.8	1041	0.8	
95	975	0.3	983	0.4	990	0.4	996	0.4	1003	0.5	1009	0.5	1015	0.6	1021	0.6	1027	0.7	1032	0.7	1037	0.8	
100	972	0.3	979	0.4	986	0.4	993	0.4	999	0.4	1005	0.5	1011	0.5	1017	0.6	1023	0.6	1028	0.6	1033	0.7	

Propylene glycol

Concentration wt %	10%		15%		20%		25%		30%		35%		40%		45%		50%		55%		60%		
	ρ [kg/m³]	v [cSt]	ρ [kg/m³]	v [cSt]	ρ [kg/m³]	v [cSt]	ρ [kg/m³]	v [cSt]	ρ [kg/m³]	v [cSt]	ρ [kg/m³]	v [cSt]	ρ [kg/m³]	v [cSt]	ρ [kg/m³]	v [cSt]	ρ [kg/m³]	v [cSt]	ρ [kg/m³]	v [cSt]	ρ [kg/m³]	v [cSt]	
Temperature																							
-50																						1077	2433.5
-45																						1075	1390.3
-40																			1070	468.8	1074	817.6	
-35																			1069	291.8	1072	494.4	
-30																	1063	157.1	1067	186.7	1071	307.2	
-25															1057	87.1	1062	102.5	1066	122.6	1069	196.0	
-20													1051	44.9	1056	58.1	1060	68.6	1064	82.6	1067	128.2	
-15											1045	22.2	1050	31.1	1054	39.8	1058	47.1	1062	56.9	1065	85.9	
-10									1039	11.4	1044	16.2	1048	22.1	1053	27.9	1056	33.2	1060	40.2	1063	58.9	
-5			1021	3.8	1027	4.8	1032	6.3	1037	8.7	1042	12.0	1047	16.0	1051	20.1	1054	23.9	1058	29.0	1061	41.4	
0	1013	2.6	1020	3.1	1025	3.9	1031	5.1	1036	6.8	1040	9.1	1045	11.9	1049	14.7	1052	17.6	1056	21.4	1059	29.7	
5	1012	2.2	1018	2.6	1024	3.2	1029	4.1	1034	5.4	1038	7.0	1043	9.0	1046	11.1	1050	13.2	1053	16.1	1056	21.7	
10	1011	1.8	1017	2.2	1022	2.7	1027	3.4	1032	4.3	1036	5.5	1040	6.9	1044	8.5	1048	10.1	1051	12.3	1053	16.2	
15	1009	1.6	1015	1.9	1020	2.3	1025	2.8	1030	3.5	1034	4.4	1038	5.5	1042	6.6	1045	7.9	1048	9.6	1051	12.3	
20	1008	1.4	1013	1.6	1019	1.9	1023	2.4	1028	2.9	1032	3.6	1036	4.4	1039	5.3	1042	6.3	1045	7.6	1048	9.6	
25	1006	1.2	1011	1.4	1017	1.7	1021	2.0	1026	2.5	1030	3.0	1033	3.6	1037	4.3	1040	5.1	1042	6.1	1045	7.5	
30	1004	1.1	1009	1.2	1014	1.4	1019	1.7	1023	2.1	1027	2.5	1031	2.9	1034	3.5	1037	4.2	1039	5.0	1042	6.0	
35	1002	0.9	1007	1.1	1012	1.3	1017	1.5	1021	1.8	1024	2.1	1028	2.5	1031	2.9	1034	3.5	1036	4.2	1038	4.9	
40	1000	0.8	1005	1.0	1010	1.1	1014	1.3	1018	1.5	1022	1.8	1025	2.1	1028	2.5	1031	2.9	1033	3.5	1035	4.0	
45	998	0.8	1003	0.9	1007	1.0	1011	1.2	1015	1.4	1019	1.6	1022	1.8	1025	2.1	1027	2.5	1030	3.0	1032	3.4	
50	995	0.7	1000	0.8	1005	0.9	1009	1.0	1012	1.2	1016	1.4	1019	1.6	1021	1.8	1024	2.2	1026	2.6	1028	2.9	
55	993	0.6	998	0.7	1002	0.8	1006	0.9	1009	1.1	1012	1.2	1015	1.4	1018	1.6	1020	1.9	1022	2.2	1024	2.4	
60	990	0.6	995	0.6	999	0.7	1003	0.8	1006	1.0	1009	1.1	1012	1.2	1014	1.4	1017	1.7	1019	1.9	1020	2.1	
65	988	0.5	992	0.6	996	0.7	999	0.8	1003	0.9	1006	1.0	1008	1.1	1011	1.3	1013	1.5	1015	1.7	1016	1.9	
70	985	0.5	989	0.5	993	0.6	996	0.7	999	0.8	1002	0.9	1005	1.0	1007	1.1	1009	1.3	1011	1.5	1012	1.6	
75	982	0.5	986	0.5	989	0.6	993	0.6	996	0.7	998	0.8	1001	0.9	1003	1.0	1005	1.2	1006	1.4	1008	1.5	
80	979	0.4	983	0.5	986	0.5	989	0.6	992	0.7	995	0.7	997	0.8	999	10.0	1001	1.1	1002	1.2	1003	1.3	
85	976	0.4	979	0.4	982	0.5	985	0.5	988	0.6	991	0.7	993	0.8	995	0.9	996	1.0	998	1.1	999	1.2	
90	972	0.4	976	0.4	979	0.4	982	0.5	984	0.6	986	0.6	988	0.7	990	0.8	992	0.9	993	1.0	994	1.1	
95	969	0.3	972	0.4	975	0.4	978	0.5	980	0.5	982	0.6	984	0.7	986	0.7	987	0.8	988	0.9	989	1.0	
100	965	0.3	968	0.3	971	0.4	974	0.4	976	0.5	978	0.6	980	0.6	981	0.7	983	0.7	984	0.8	984	0.9	

Sodium hydroxide

	ρ	v	ρ	v	ρ	v	ρ	v	ρ	v	ρ	v	ρ	v	ρ	v	ρ	v	ρ	v	ρ	v	
	[kg/m ³]	[cSt]	[kg/m ³]	[cSt]	[kg/m ³]	[cSt]	[kg/m ³]	[cSt]	[kg/m ³]	[cSt]	[kg/m ³]	[cSt]	[kg/m ³]	[cSt]	[kg/m ³]	[cSt]	[kg/m ³]	[cSt]	[kg/m ³]	[cSt]	[kg/m ³]	[cSt]	
Concentration wt % =	5%		10%		15%		20%		25%		30%		35%		40%		45%		50%		55%		
Temperature																							
0	1060		1117		1174		1230		1285		1334		1384		1435		1483		1530		1559		
5	1058		1115		1172		1227		1283		1332		1381		1429		1480		1528		1556		
10	1057		1113		1170		1224		1280		1330		1377		1423		1478		1525		1553		
15	1056		1111		1167		1222		1277		1326		1372		1420		1471		1518		1546		
20	1054	1.3	1109	1.7	1164	2.5	1219	3.6	1274	6.2	1322	10.1	1367	16.8	1416	25.4	1464	38.2	1511	51.8	1540		
25	1052	1.1	1107	1.5	1162	2.1	1217	3.1	1271	5.1	1319	8.3	1364	13.3	1413	19.9	1461	29.0	1508	39.0			
30	1050	1.0	1104	1.3	1159	1.8	1214	2.7	1268	4.0	1315	6.5	1360	9.9	1410	14.4	1457	19.9	1504	26.2			
35	1048	0.9	1102	1.2	1157	1.6	1211	2.3	1265	3.4	1312	5.5	1357	8.2	1407	11.6	1454	15.9	1501	20.5			
40	1046	0.8	1100	1.1	1154	1.4	1208	2.0	1262	2.8	1309	4.5	1353	6.6	1403	8.9	1450	12.0	1497	14.7			
45	1044	0.7	1097	1.0	1151	1.3	1205	1.8	1259	2.6	1306	3.9	1347	5.6	1396	7.5	1443	9.9	1490	12.1			
50	1042	0.7	1094	0.9	1148	1.2	1202	1.6	1256	2.3	1302	3.3	1340	4.6	1389	6.0	1436	7.8	1483	9.4			
55	1039	0.6	1092	0.8	1145	1.0	1199	1.5	1253	2.0	1299	2.9											
60	1036	0.6	1089	0.7	1143	0.9	1196	1.3	1250	1.8	1295	2.4											
65	1033	0.5	1086	0.7	1140	0.9	1193	1.2	1246	1.6													
70	1030	0.5	1083	0.6	1137	0.8	1190	1.1	1243	1.5													
75	1027		1080		1134		1186		1240														
80	1025		1077		1131		1183		1237														



Calcium chloride

	ρ	v	ρ	v	ρ	v	ρ	v
	[kg/m ³]	[cSt]	[kg/m ³]	[cSt]	[kg/m ³]	[cSt]	[kg/m ³]	[cSt]
Concentration wt % =	10%		15%		20%		25%	
Temperature								
-25							1245	7.7
-20							1244	6.3
-15					1189	4.3	1242	5.2
-10			1138	3.0	1188	3.6	1241	4.4
-5	1090	2.3	1137	2.6	1187	3.1	1239	3.8
0	1088	2.0	1135	2.2	1186	2.6	1237	3.3
5	1086	1.7	1134	1.9	1184	2.3	1235	2.9
10	1085	1.5	1132	1.7	1182	2.0	1233	2.5
15	1083	1.3	1131	1.5	1180	1.8	1230	2.2
20	1082	1.1	1129	1.3	1178	1.6	1228	2.0
25	1082	1.0	1127	1.2	1176	1.4	1226	1.8
30	1081	0.9	1125	1.0	1173	1.3	1223	1.6

Natrium chloride

	ρ	v	ρ	v	ρ	v	ρ	v
	[kg/m ³]	[cSt]	[kg/m ³]	[cSt]	[kg/m ³]	[cSt]	[kg/m ³]	[cSt]
Concentration wt % =	5%		10%		15%		20%	
Temperature								
-15							1162	4.0
-10					1120	2.9	1160	3.2
-5			1082	2.2	1118	2.4	1158	2.7
0	1043	1.8	1080	1.8	1116	2.0	1155	2.3
5	1042	1.5	1079	1.6	1114	1.7	1153	1.9
10	1041	1.3	1077	1.4	1112	1.5	1151	1.7
15	1040	1.1	1075	1.2	1110	1.3	1148	1.5
20	1039	1.0	1074	1.1	1108	1.2	1146	1.3
25	1037	0.9	1072	0.9	1106	1.0	1144	1.2
30	1036	0.8	1070	0.9	1103	0.9	1141	1.1

Index

A

Absolute pressure	83
Adjusting pump performance	104
Aluminium	68
Asynchronous motor	38
ATEX (ATmosphère EXplosible)	39
Austenitic (non-magnetic)	66
Autotransformer starting	44
Axial flow pumps	8
Axial forces	12

B

Balanced shaft seal	28
Basic coupling	16
Bearing	49
Insulated bearing	46
Bellows seal	29
Borehole pump	22
Bypass control	104

C

Canned motor pump	18
Cartridge seal	30
Casing	15
Double-volute	15
Single-volute	15
Return channel	15
Cast iron	64
Cavitation	10, 87
Cavitation corrosion	61
Centrifugal pump	8
Ceramics	69
Close-coupled pump	12, 13, 16
Closed system	94, 96
Coatings	71
Metallic coatings	71
Non-metallic coatings	72
Organic coatings	72
Computer-aided pump selection	56
Control	104
Throttle control	105
Bypass control	105

Speed control	106
Constant differential pressure control	113
Constant pressure control	112
Constant temperature control	113
Copper alloys	67
Corrosion	58
Cavitation corrosion	61
Corrosion fatigue	62
Crevice corrosion	60
Erosion corrosion	61
Galvanic corrosion	62
Intergranular corrosion	60
Pitting corrosion	59
Selective corrosion	60
Stress corrosion cracking (SCC)	61
Uniform corrosion	59
Corrosion fatigue	62
Coupling	16
Basic coupling	16
Flexible coupling	16
Spacer coupling	16
Crevice corrosion	60

D

Decommissioning and disposal costs	129
Deep well pump	22
Density	10, 91
Unit	Appendix A
Water	Appendix D
Brine	Appendix L
Diaphragm pump	23
Differential pressure	86
Differential pressure control	114
Dilatant liquid	53
Direct-on-line starting (DOL)	44
Dosing pump	23
Double mechanical shaft seal	31
Double seal in tandem	31
Double seal in back-to-back	32
Double-channel impeller	20
Double-inlet	17
Double-suction impeller	11, 17
Double-volute casing	15
Downtime costs	129

Index

L

Life cycle costs	115, 126
Example	130
Liquid	52
Dilatant	53
Newtonian	53
Non-Newtonian	53
Plastic fluid	53
Thixotropic	53
Viscous	52
Long-coupled pump	12, 13, 16
Loss of production costs	129

M

Magnetic drive	19
Maintenance and repair costs	129
Martensitic (magnetic)	66
Mass flow	81
Measuring pressure	83
Mechanical shaft seal	18, 26
Bellows seal	29
Cartridge seal	30
Metal bellows seal	30
Rubber bellows seal	29
Function	27
Flushing	30
Metal alloys	63
Ferrous alloys	63
Metal bellows seal	30
Metallic coatings	71
Mixed flow pumps	8
Modifying impeller diameter	106, 108
Motors	38
Motor efficiency	47
Motor insulation	46
Motor protection	47
Motor start-up	44
Direct-on-line starting (DOL)	44
Star/delta starting	44
Autotransformer starting	44
Frequency converter	44, 45
Soft starter	44
Mounting of motor (IM)	41
Multistage pump	11, 12, 13, 16

N

NEMA, motor standard	38
Newtonian fluid	53
Nickel alloys	67
Nitrile rubber	70
Nodular iron	64
Noise (vibration)	76
Non-metallic coatings	72
Non-Newtonian liquid	53
Non-sinusoidal current	122
Non-sparking motor	40
NPSH (Net Positive Suction Head)	10, 87

O

Open system	94, 97
Operating costs	104, 128
Organic coatings	72
O-ring seal	29
Oversized pumps	104

P

Paints	72
Perfluoroelastomers (FFKM)	70
Phase insulation	46
PI-controller	112
Pitting corrosion	59
Plastic fluid	53
Plastics	69
Plinth	77
Power consumption	10, 89
Hydraulic power	10, 89
Shaft power	89
Pressure	82
Absolute pressure	83
Differential pressure	86
Dynamic pressure	82
Gauge pressure	83
Measuring pressure	83
Static pressure	82
System pressure	86
Units	83, Appendix A
Vapour pressure	88, Appendix D

Pressure control		
Constant differential pressure control	113	
Constant pressure	112	
Constant pressure control	117	
Constant supply pressure	112	
Pressure transmitter (PT)	112	
Proportional pressure control	118	
PTC thermistors	48	
Pulse Width Modulation (PWM)	121	
Pump		
Axial flow pump	8	
Borehole pump	22	
Canned motor pump	18	
Centrifugal pump	8	
Close-coupled pump	12, 13, 16	
Diaphragm pump	23	
Dosing pump	23	
Hermetically sealed pump	18	
Horizontal pump	12, 13	
Immersible pump	21	
Long-coupled pump	12, 13, 16	
Magnetic-driven pump	19	
Mixed flow pump	8	
Multistage pump	11, 12, 13, 16	
Radial flow pump	8	
Single-stage pump	15	
Split-case pump	12, 13, 17	
Standard pump	17	
Vertical pump	12, 13	
Wastewater pump	20	
Pump casing	15	
Pump characteristic	9, 94	
Pump curve	9	
Pump installation	75	
Pump performance curve	9, 94	
Pumps connected in series	101	
Pumps in parallel	99	
Pumps with integrated frequency converter	116	
Purchase costs	127	
PWM (Pulse Width Modulation)	121	
Q		
QH curve		9
R		
Radial flow pump		8
Radial forces		15
Reinforced insulation		46
Resistances connected in parallel		96
Resistances connected in series		95
Return channel casing		11, 15
Rubber		70
Ethylene propylene rubber (EPDM)		70
Fluoroelastomers (FKM)		70
Nitrile rubber (NBK)		70
Perfluoroelastomers (FFKM)		70
Silicone rubber (Q)		70
Rubber bellows seal		29
S		
Seal face		26
Seal gab		27
Selective corrosion		60
Setpoint		112
Shaft		11
Shaft power		89
Shaft seal		26
Balanced shaft seal		28
Unbalanced shaft seal		28
Silicone rubber (Q)		70
Single resistances		95
Resistances connected in series		95
Single-channel impeller		20
Single-stage pump		11, 12, 13, 15
Single-suction impeller		11
Single-volute casing		15
Soft starter		44
Sound level		79
Sound pressure level		80
Spacer coupling		16

Speed control	104, 106, 108		
Variable speed control	106		
Speed-controlled pumps in parallel	100		
Split-case pump	12, 13, 17		
Stainless steel	64		
Standard pump	17		
Standards	38		
IEC, motor	38		
NEMA, motor	38		
Standstill heating of motor	49		
Star/delta starting	44		
Static pressure	82		
Steel	63		
Stress corrosion cracking (SCC)	61		
Stuffing box	26		
Submersible pump	22		
System characteristic	94		
Closed system	94, 96		
Open system	94, 97		
System costs	115		
System pressure	86		
T			
Temperature		91	
Units		Appendix B	
Thermoplastics		69	
Thermosets		69	
Thixotropic liquid		53	
Throttle control		104, 108-111	
Throttle valve		105	
Titanium		68	
Twin pump		11	
U			
Unbalanced shaft seal		28	
Uniform corrosion		59	
V			
Vapour pressure		88, Appendix D	
Variable speed control		106	
Vertical pump		12, 13	
Vibration dampeners		77	
Vibrations		76	
Viscosity		52, Appendix L	
Dynamic viscosity		52	
Viscous liquid		52	
Viscous liquid pump curve		53	
Voltage supply		45	
Volume flow		81	
Units		Appendix A	
Volute casing		11	
Vortex impeller		20	
Wastewater pump		20	

